



P-47D Thunderbolt 60 Kit

Code : SEA 207K

ASSEMBLY MANUAL

“Graphics and specifications may change without notice”.



Specifications:

Wingspan----- 63.0 in (160.0 cm).
Wing area----- 728.5 sq.ins (47.0 sq.dm).
Weight----- 9.3-9.9 lbs (4.2-4.5 kg).
Length----- 51.8 in (131.5 cm).
Engine ----- 0.61 - 0.91 cu.in----2 stroke.
----- 0.91- 1.00 cu.in----4 stroke.
----- 15cc gasoline engine .
Radio----- 6 channels with 9 servos.

INTRODUCTION

- Congratulations and thank you for purchasing the P47 Thunderbolt. We are pleased to bring you this scale P47. with this kit you can achieve whatever level of detail you like. Just by following the instruction and finishing the plane in scale-looking trim scheme, beginning scale modelers will end up with a model that very much represents and full-size P47. Experienced builders will find ways to add even more detail, making the P47 Thunderbolt competitive in scale contents.

GETTING PREPARE TO BUILD AS

- Here is a list of supplies you should have on hand while you are building. Some of these are optional. Use your own experience to decide what you need.

- Getting prepare to build as:
- Flat Iron
- White Glue
- CA Glue
- Epoxy Glue
- Ruler
- Cutter
- Sandpaper Bar
- Aluminium Square Fixed Tool

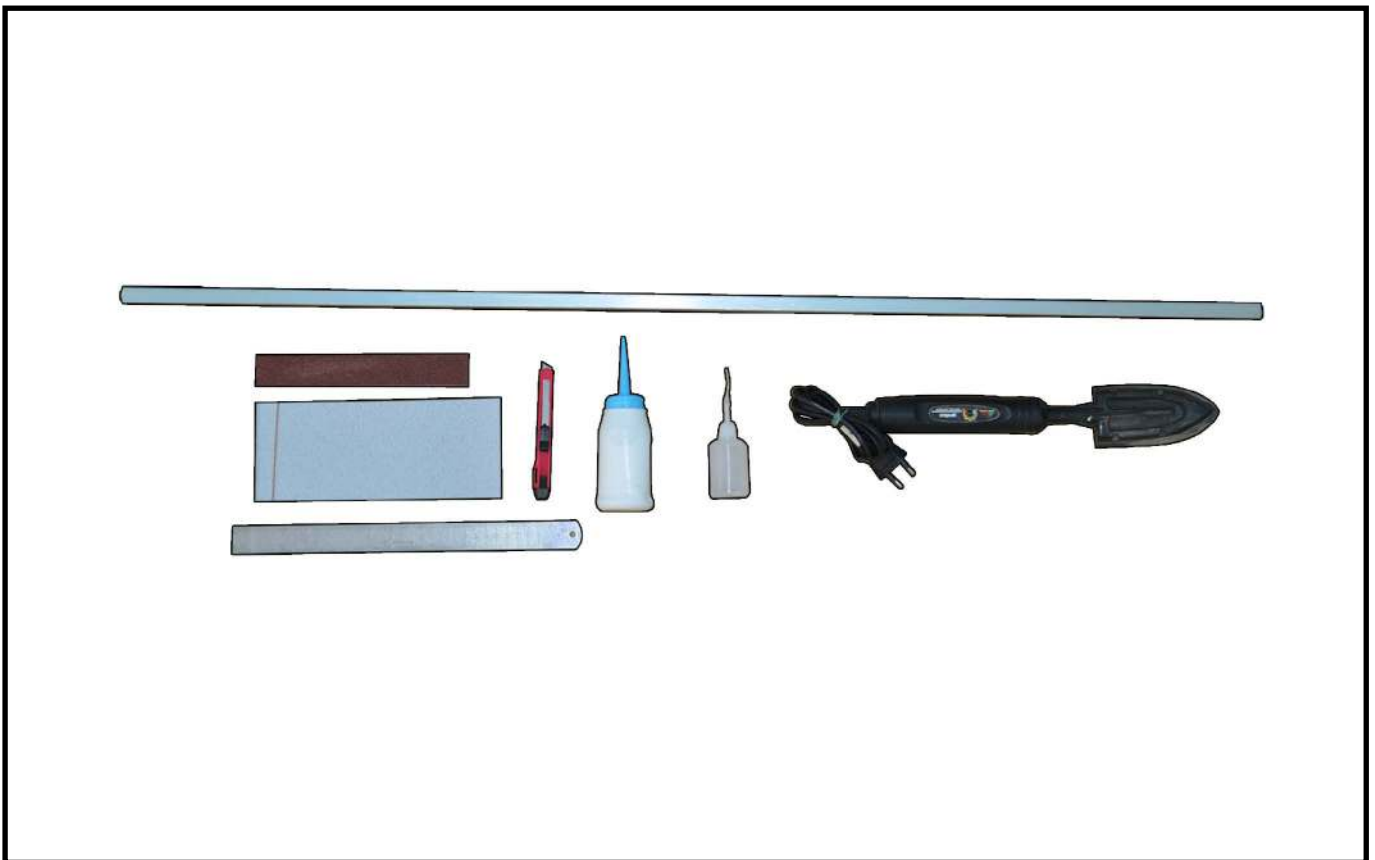

DIE-CUT PATTERNS

2.7mm balsa plywood (1 per kit)

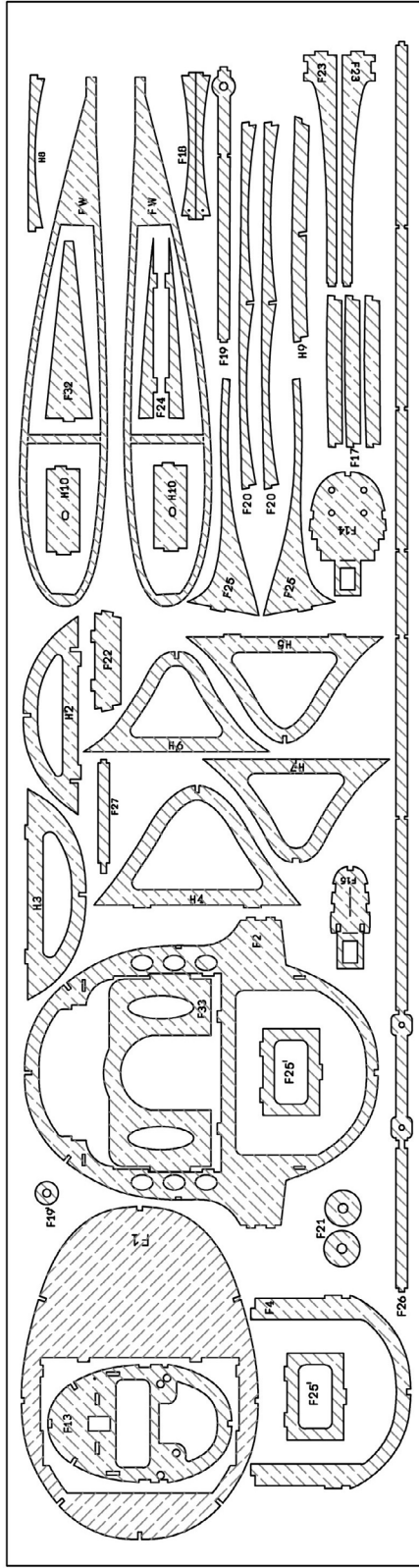

2.7mm balsa plywood (1 per kit)

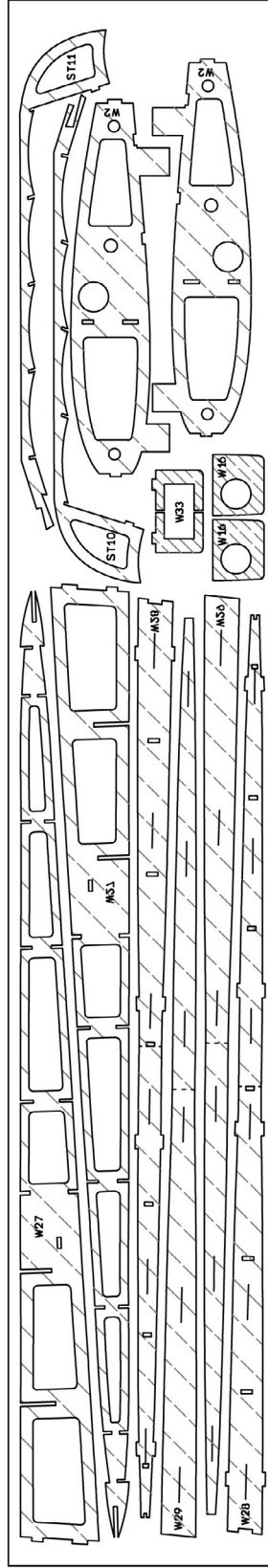

2.7mm balsa plywood (1 per kit)

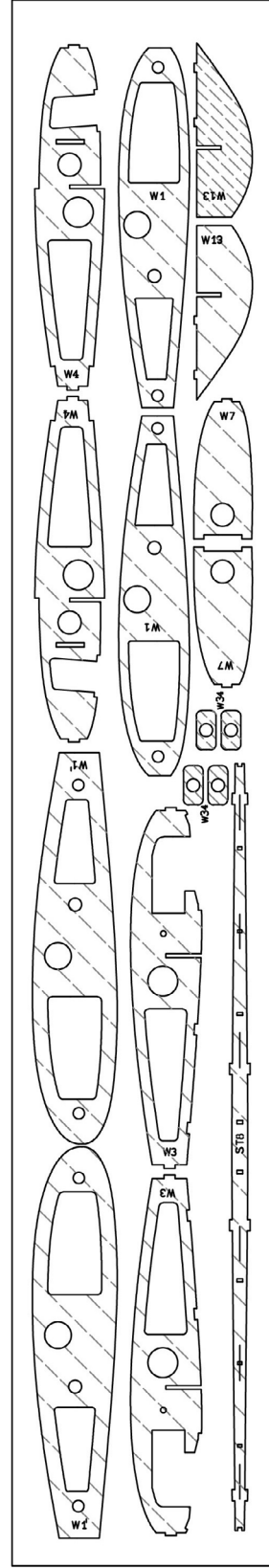

DIE-CUT PATTERNS

2mm balsa plywood (1 per kit)

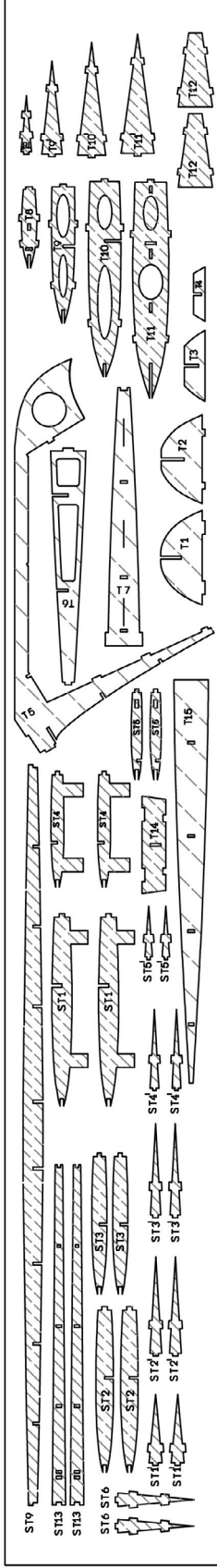

2mm balsa plywood (1 per kit)

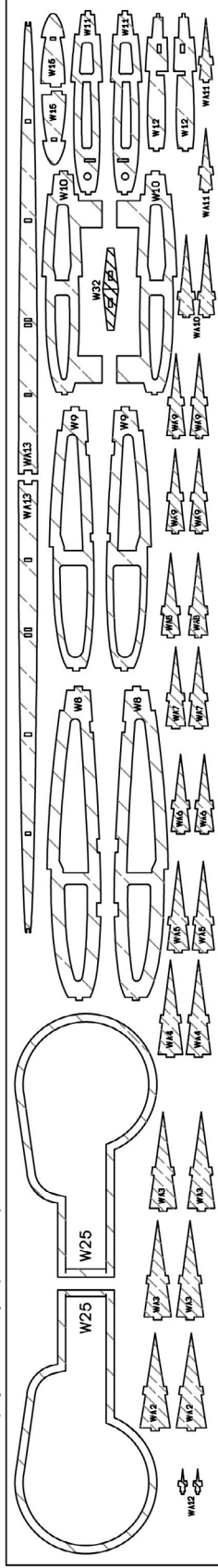

2mm plywood (1 per kit)

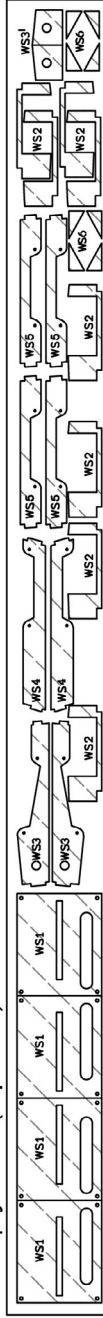

2mm balsa sheet (1 per kit)

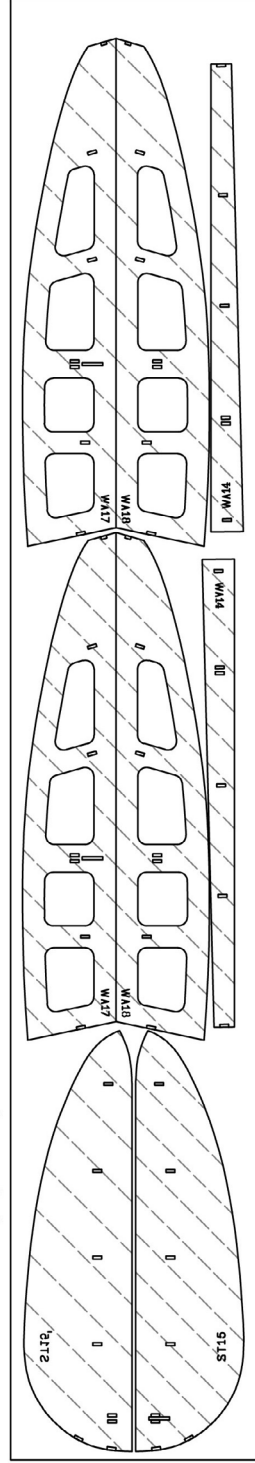

DIE-CUT PATTERNS

3mm plywood (1 per kit)

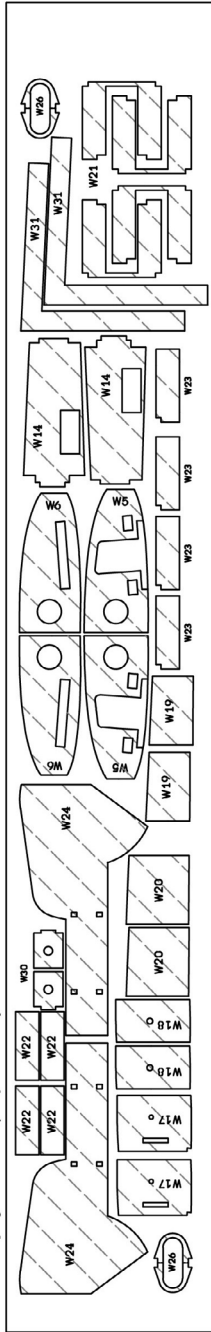

2mm balsa sheet (1 per kit)

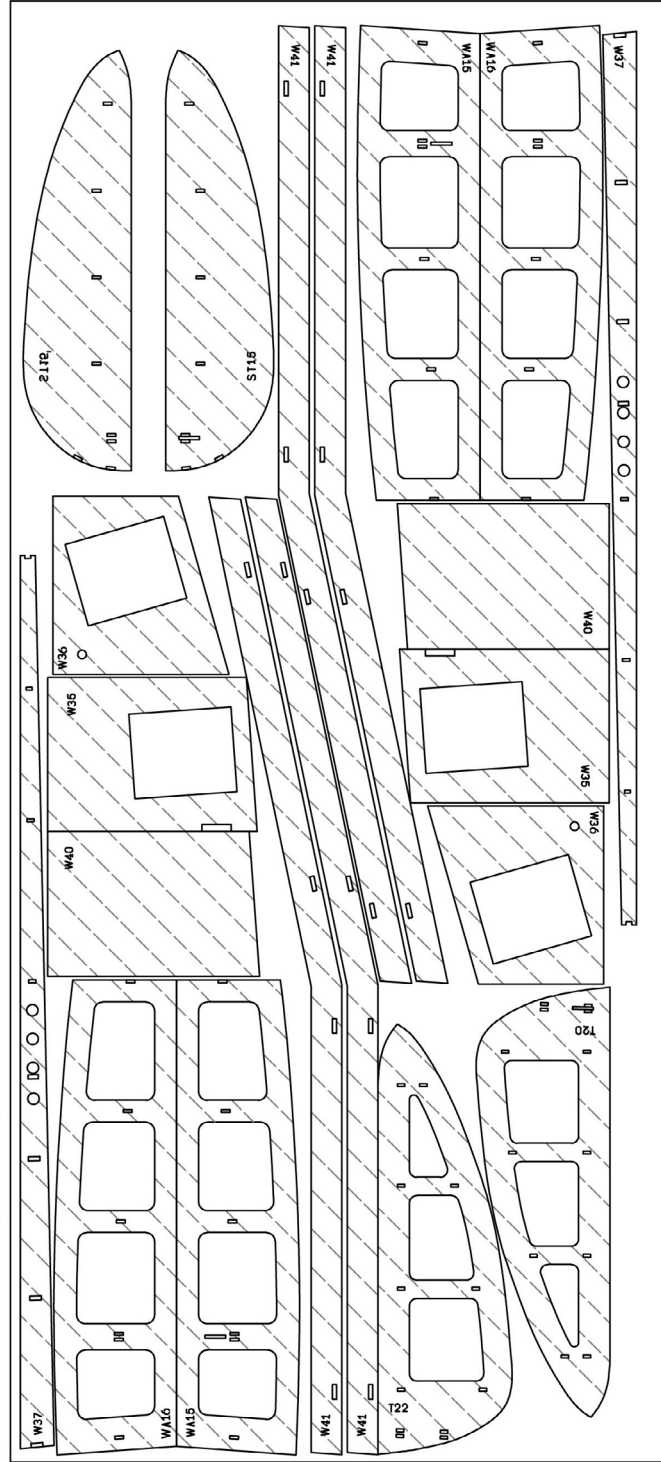

DIE-CUT PATTERNS

3mm plywood (1 per kit)

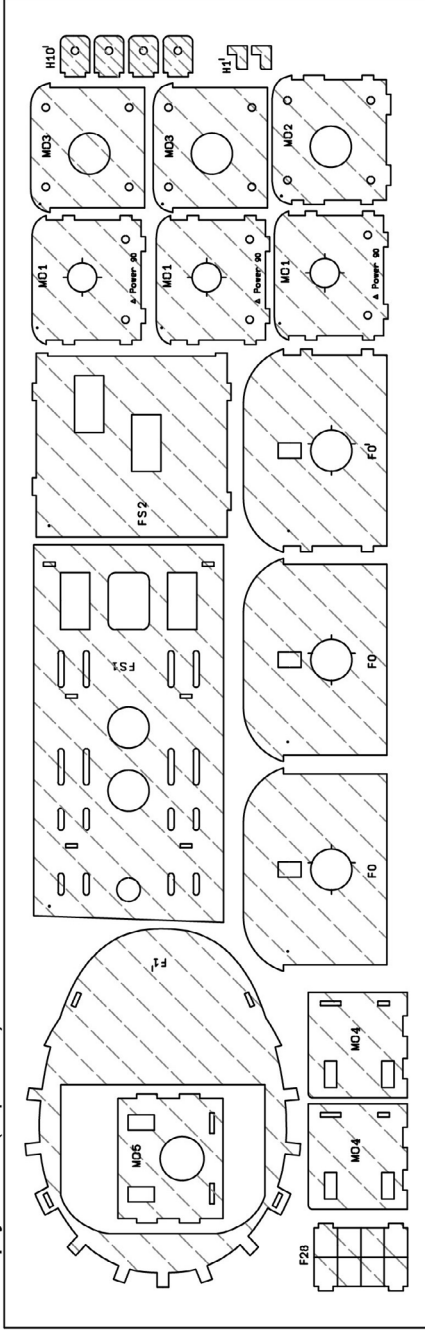

2mm balsa sheet (1 per kit)

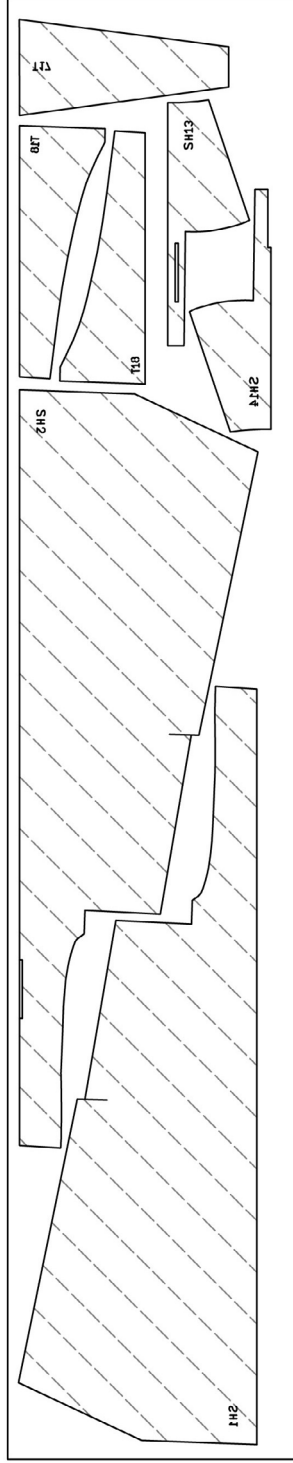

2mm balsa sheet (1 per kit)

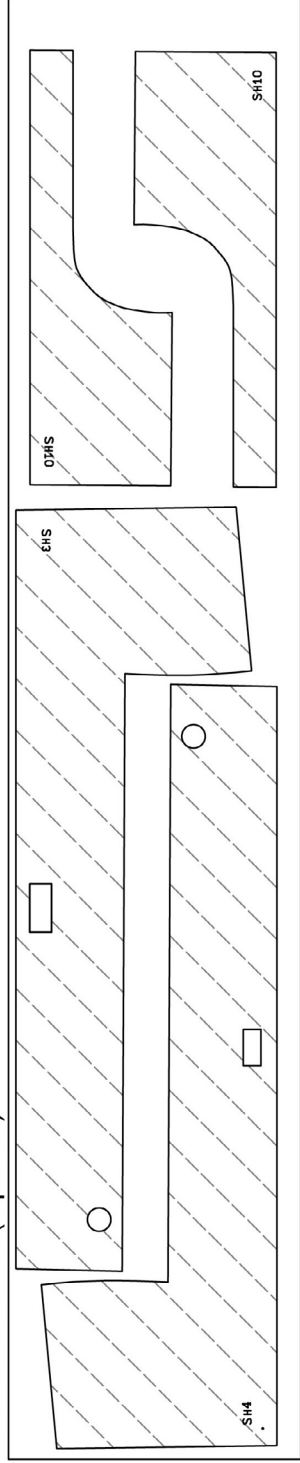

DIE-CUT PATTERNS

2mm balsa sheet (2 per kit)

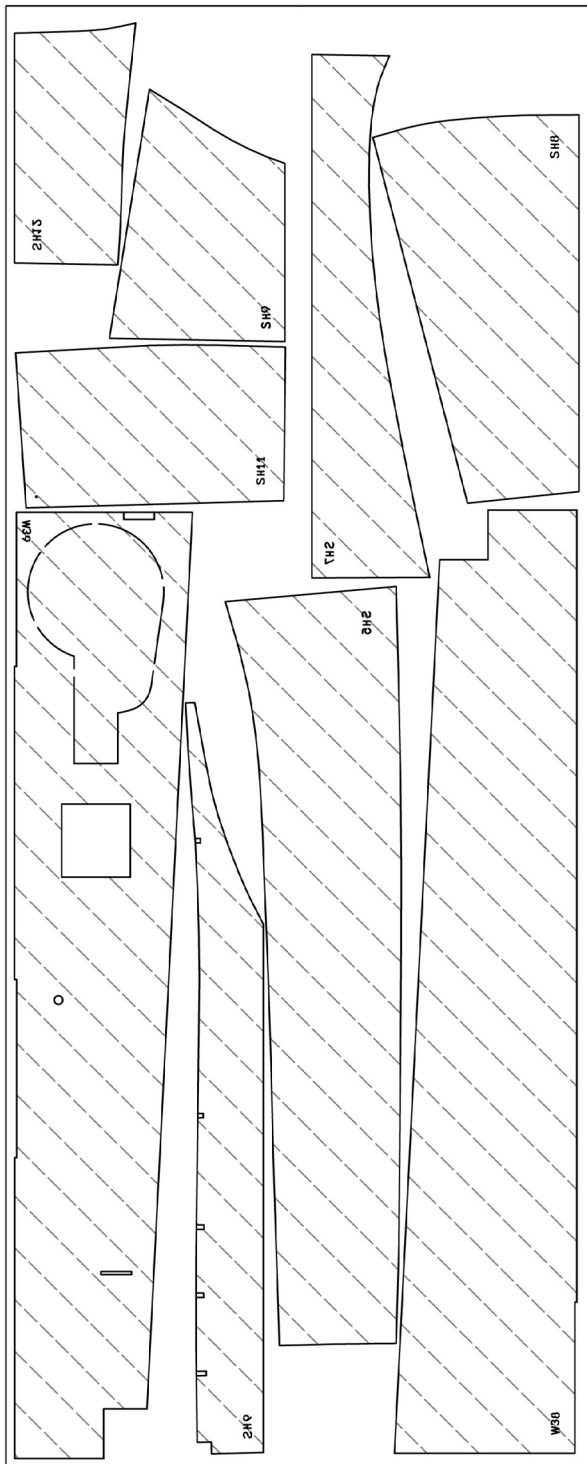

2mm balsa sheet (1 per kit)

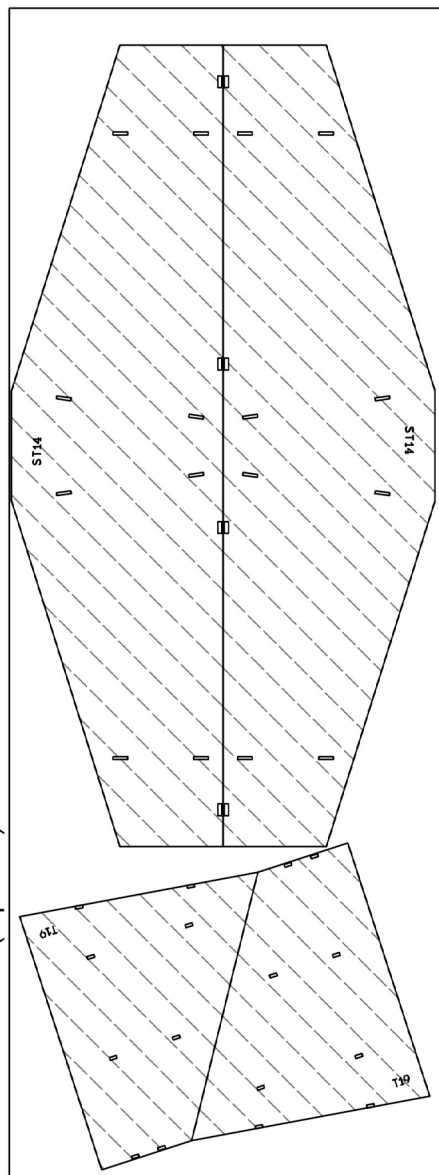

BUILD THE FUSELAGE

1.

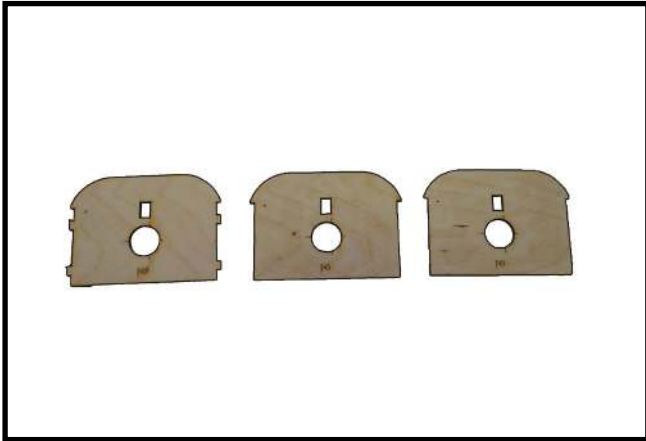

- Firewall (3pcs).

2.

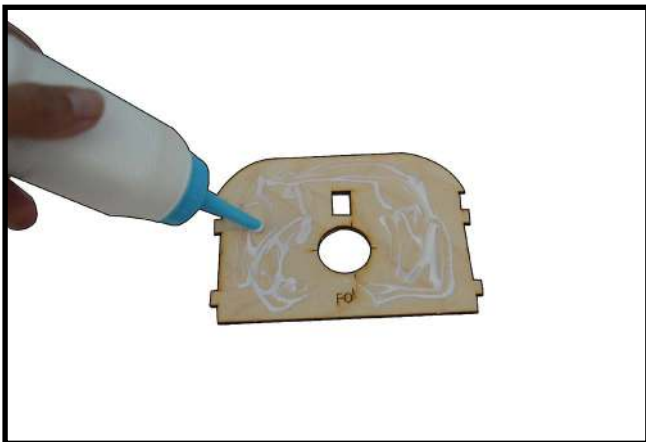

- Apply White Glue to the surface of the firewall F0'.

3.



- Put the 1st firewall F0 on firewall F0' to paste them together.

4.

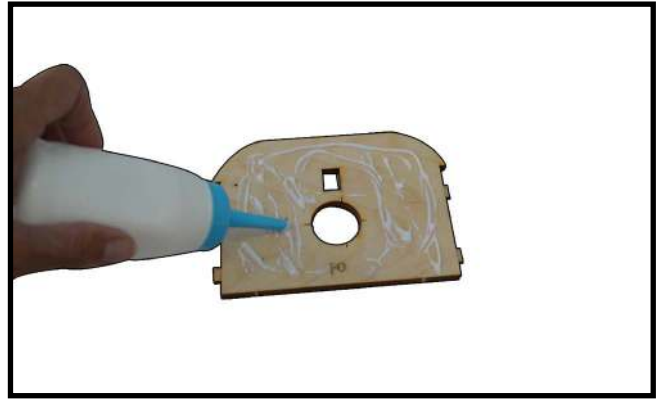

- Fill White Glue on the surface of the 1st firewall F0.

5.



- Put the 2nd firewall F0 on 1st firewall F0 to paste them together.

6.

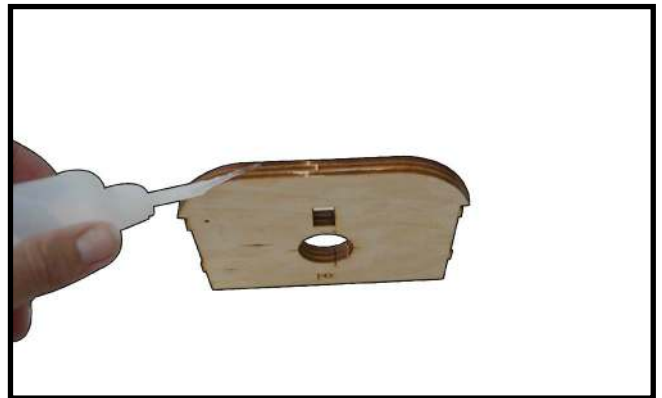

- Apply Epoxy around block include 3 layers firewall.

7.

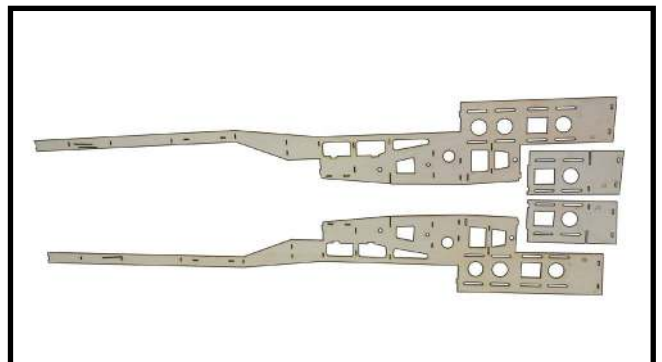

- Arrange the left fuselage side S1, S1' and the right fuselage side S2, S2' as photo for difference between inside surface and outside surface.

Please kindly see in the drawing sheet so that avoiding mistake at this step.

8.

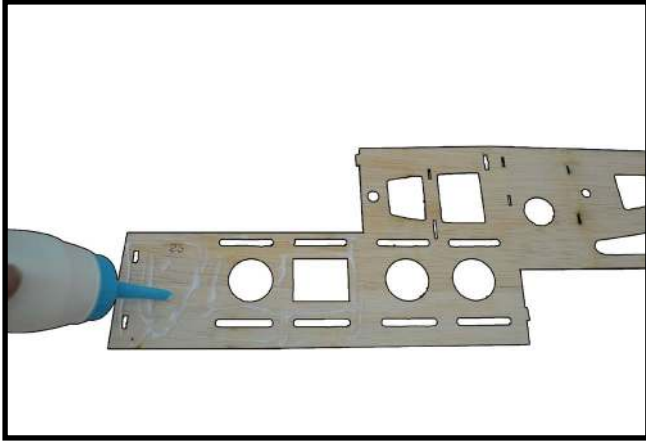

- Apply White Glue to the surface of right fuselage side S2 at area need to paste S2'.

9.

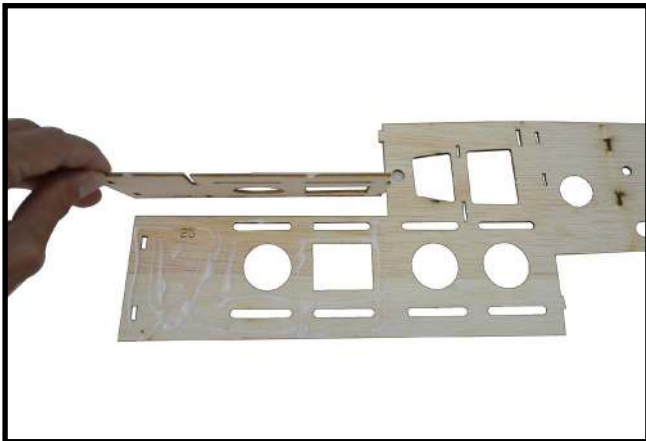

- Put the right fuselage side S2' on the right fuselage side S2 to paste them together.

10.

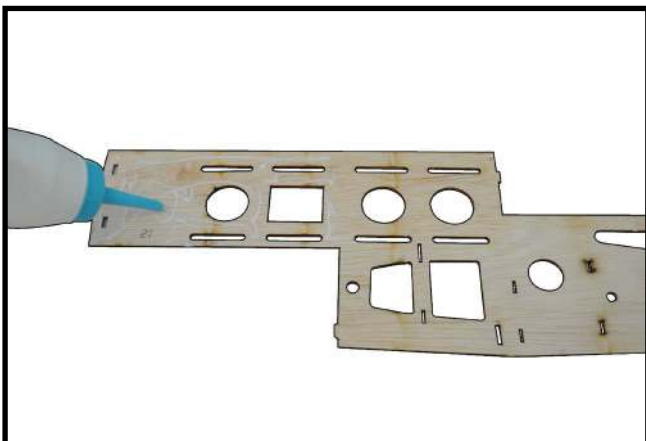

- Apply White Glue to the surface of left fuselage side S1 at area need to paste S1'.

11.

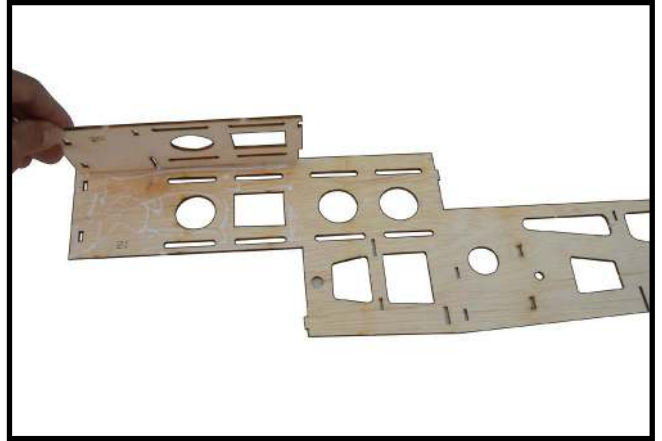

- Put the left fuselage side S1' on the left fuselage side S1 to paste them together.

12.

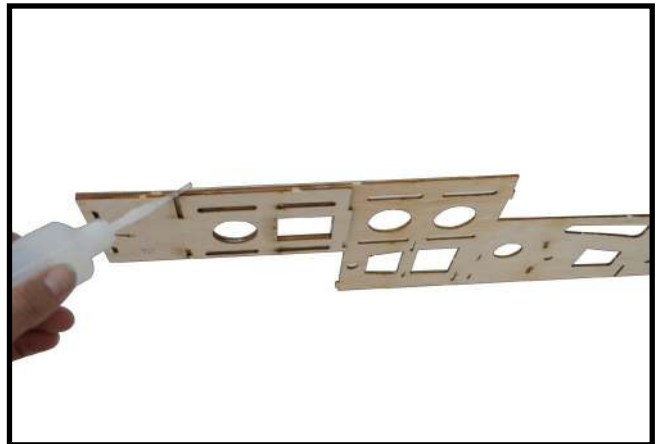

- Apply thin CA Glue around block include 2 layers the fuselage side.

13.

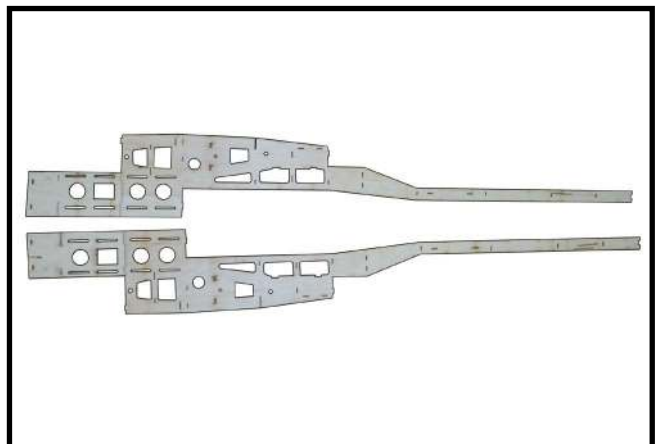

- Fuselage was finished.

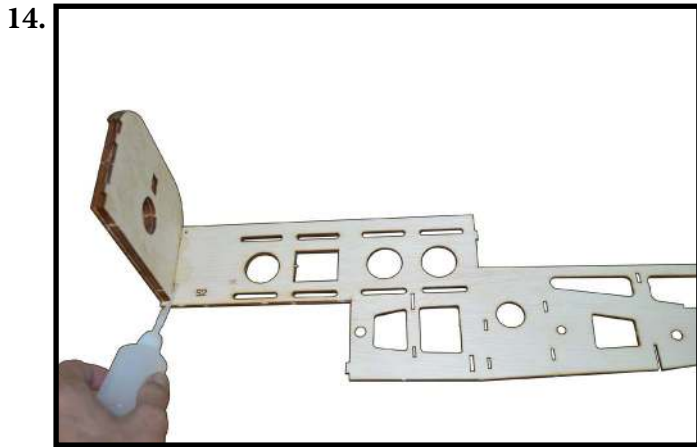

- Install firewall block with the right fuselage side S2,S2' by Epoxy glue.

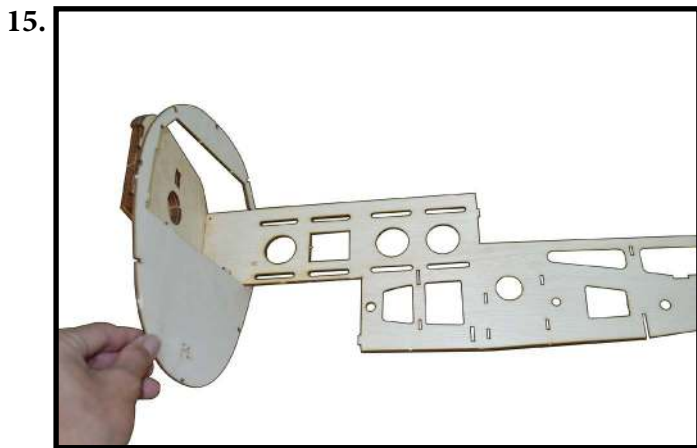

- Put former F1 on the right fuselage side S2,S2'.

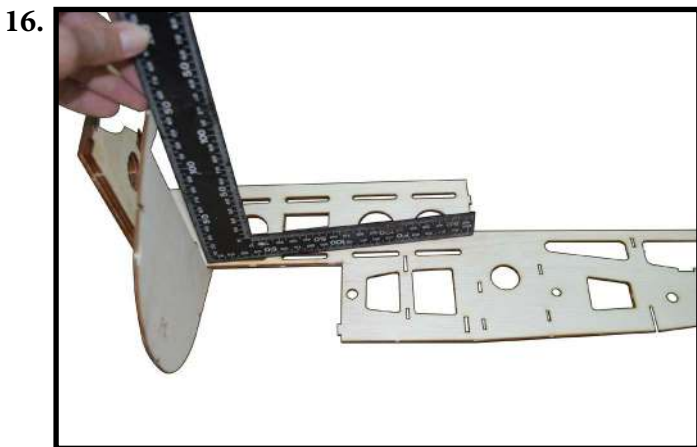

- Use the ruler to adjust perpendicular angle of former F1 and the right fuselage side S2, S2'.

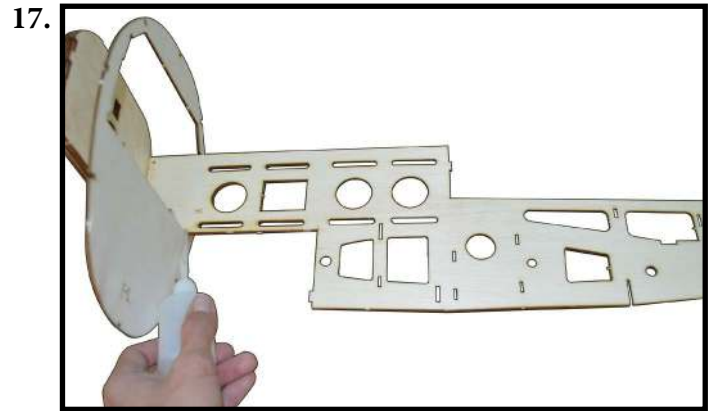

- Apply CA Glue to keep fixed former F1 and the right fuselage side S2, S2'.

Continue to install former F13 as the instruction photos below.

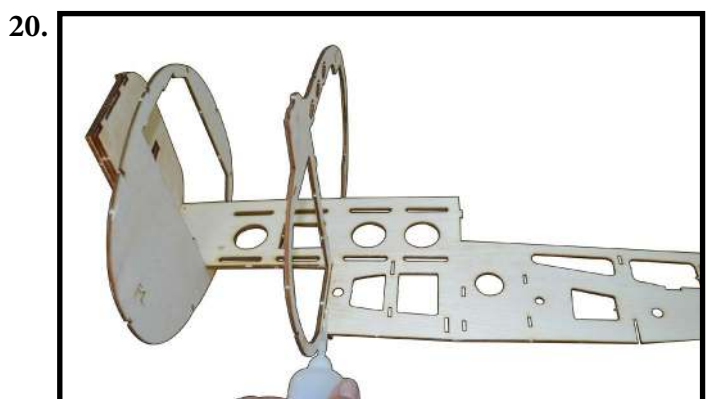
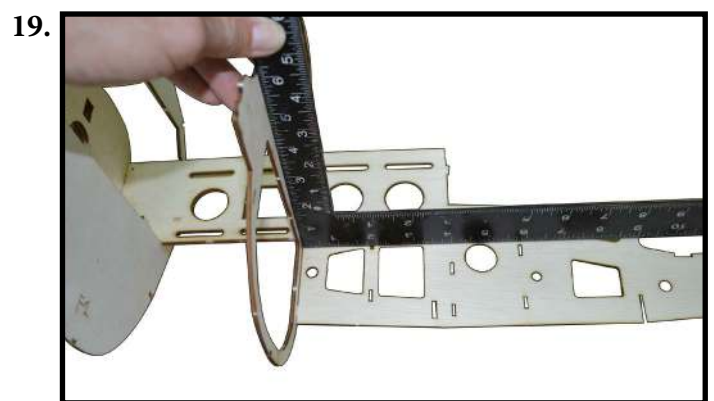
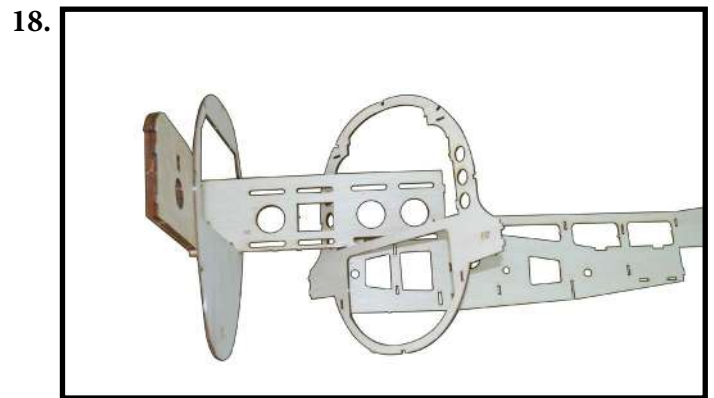

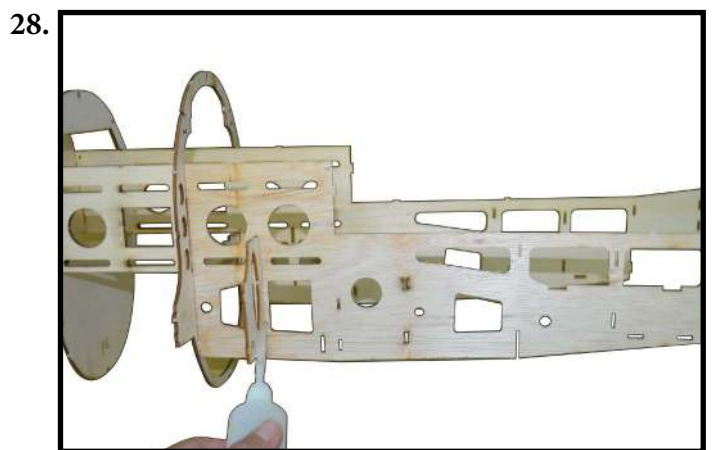
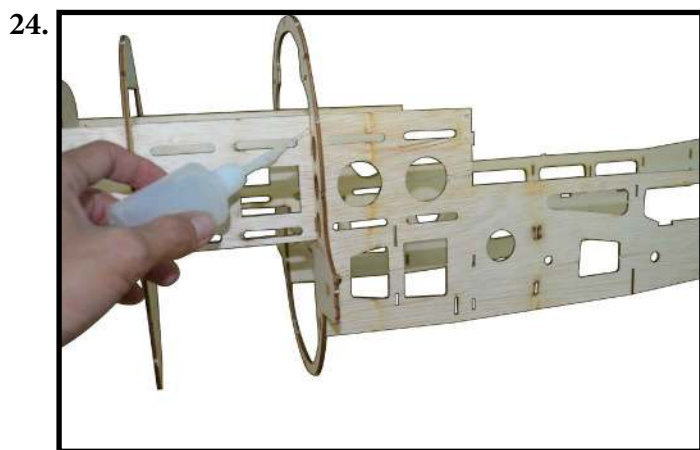
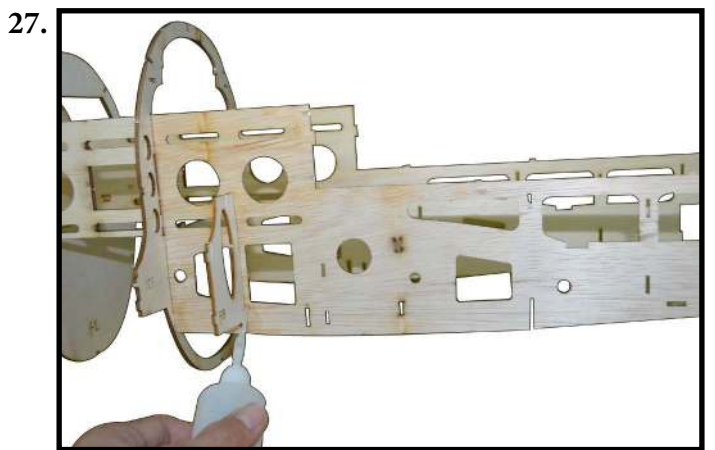
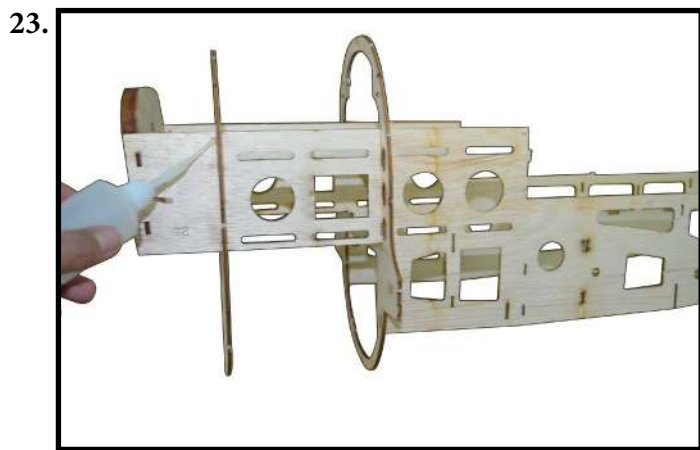
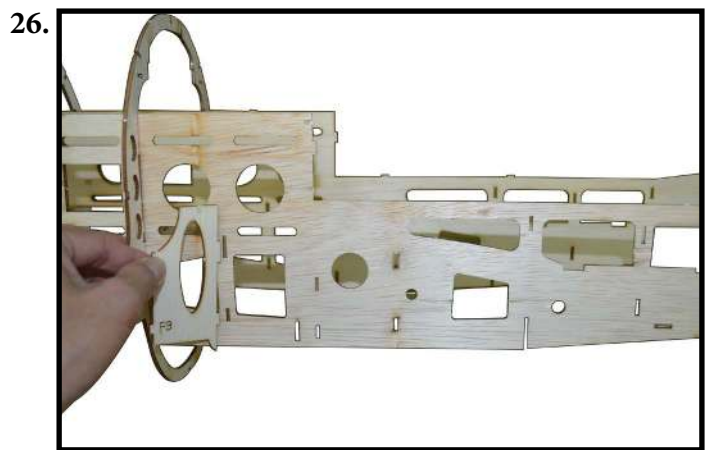
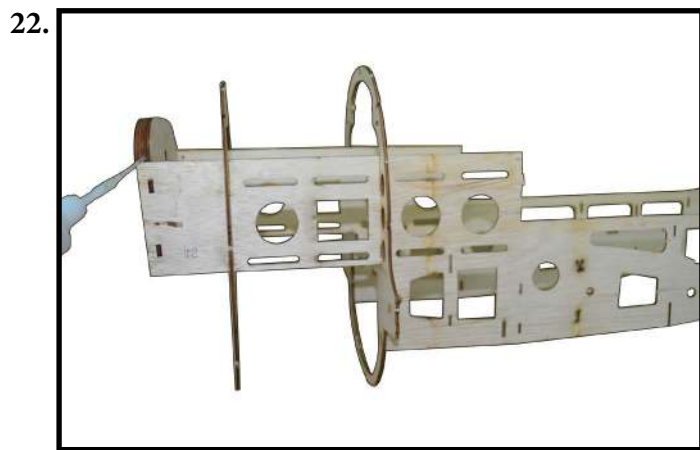
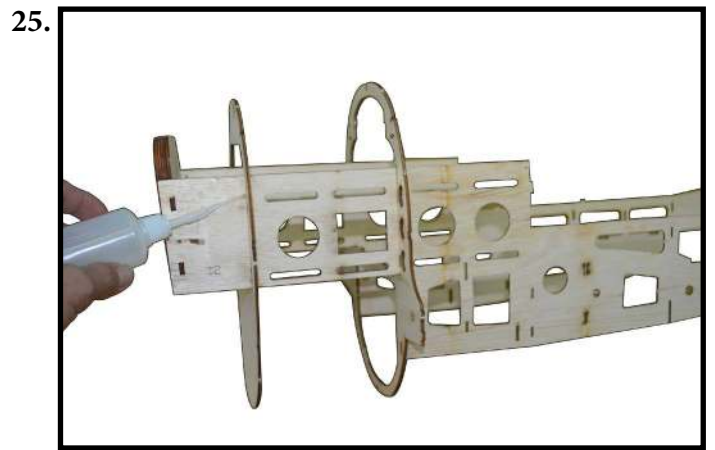
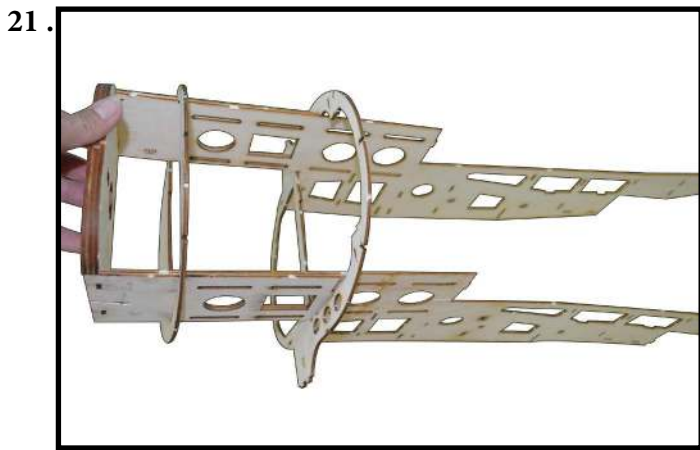

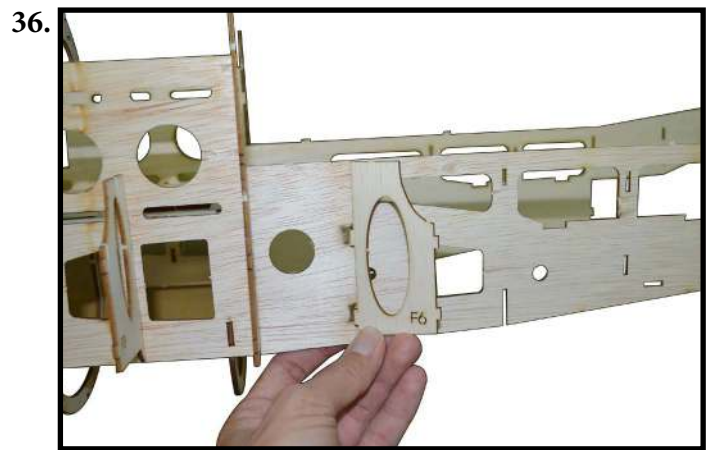
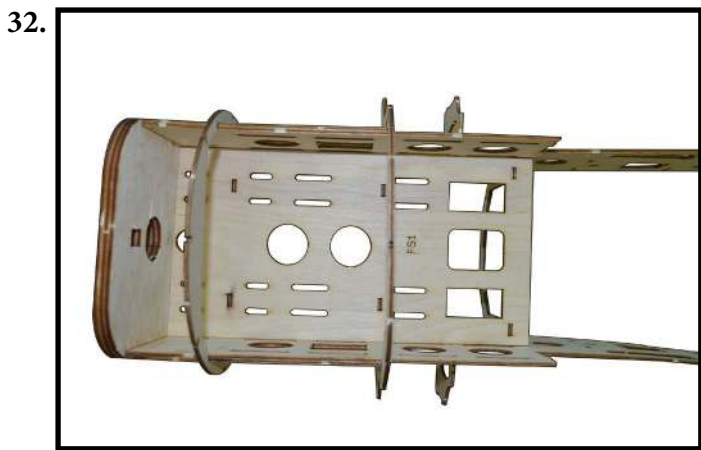
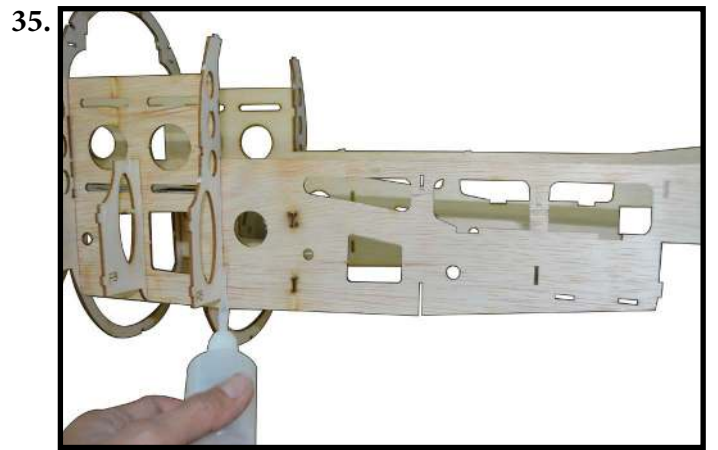
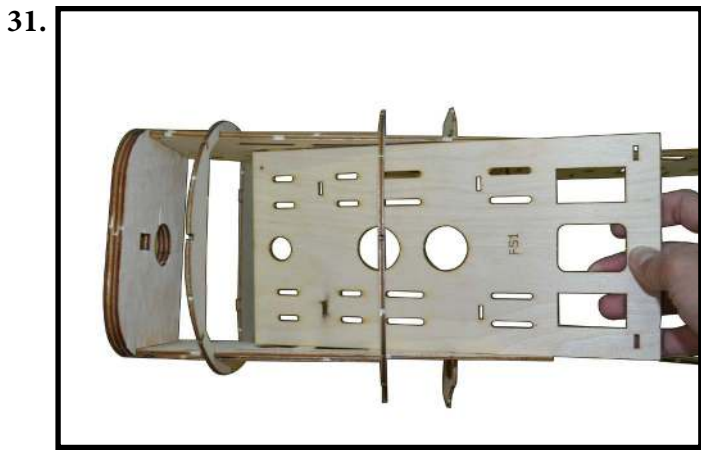
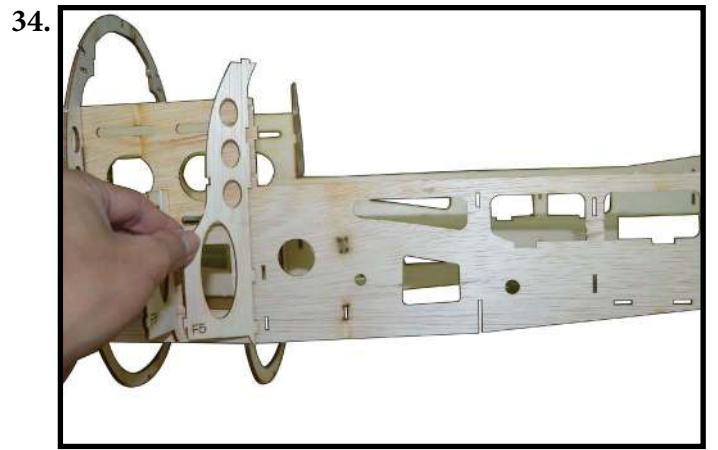
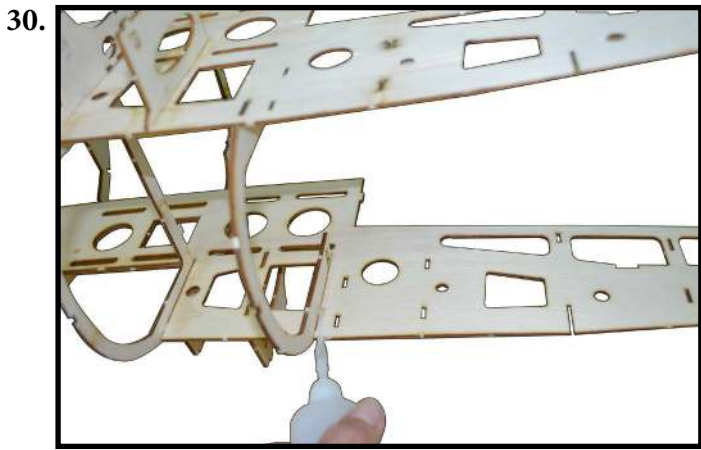
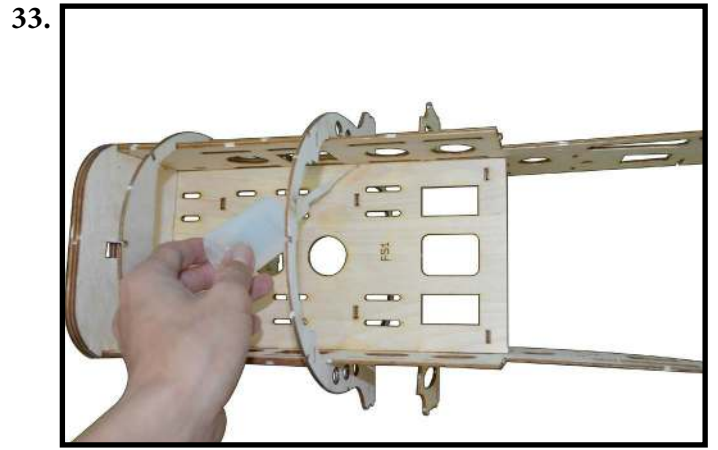
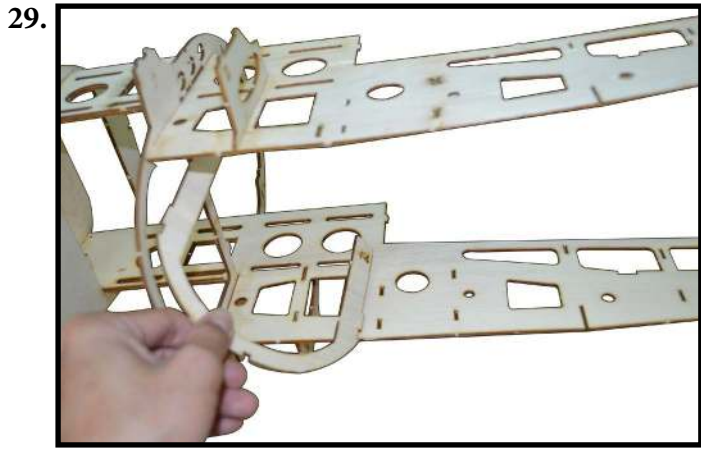

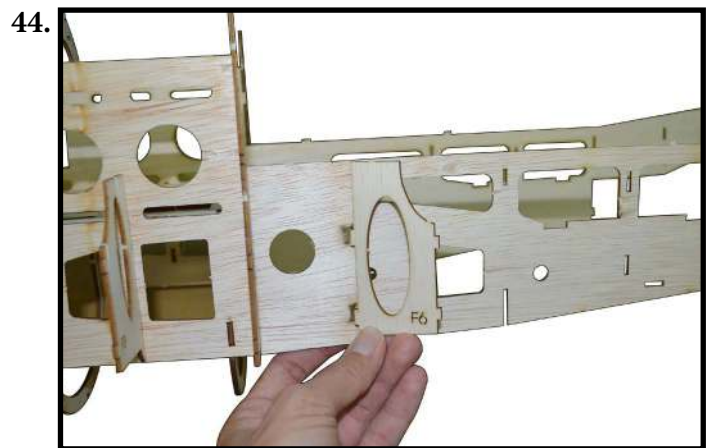
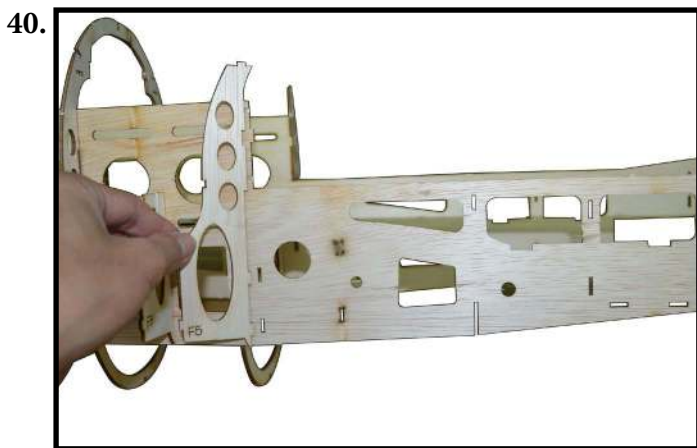
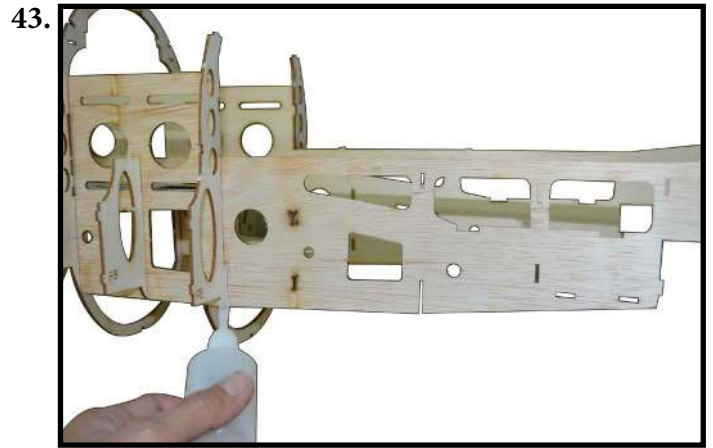
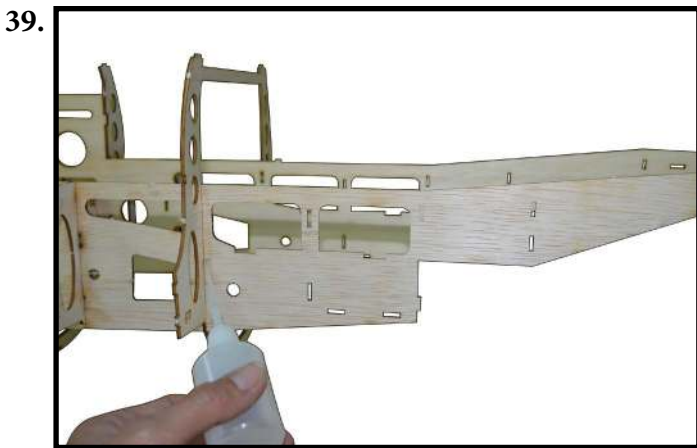
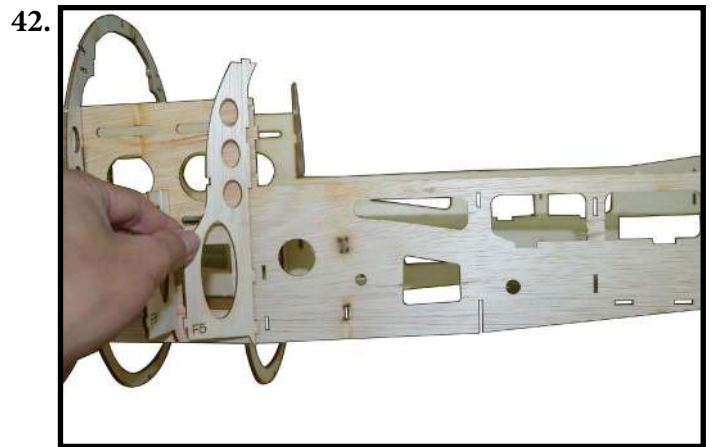
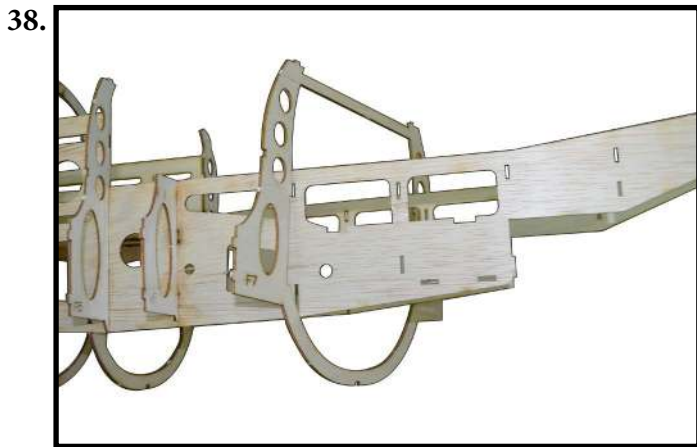
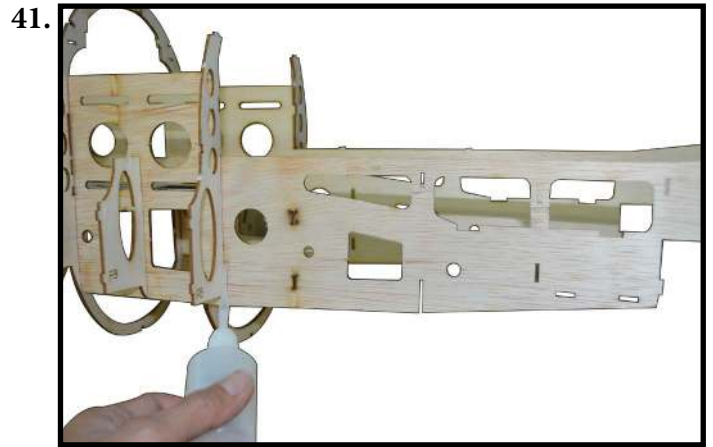
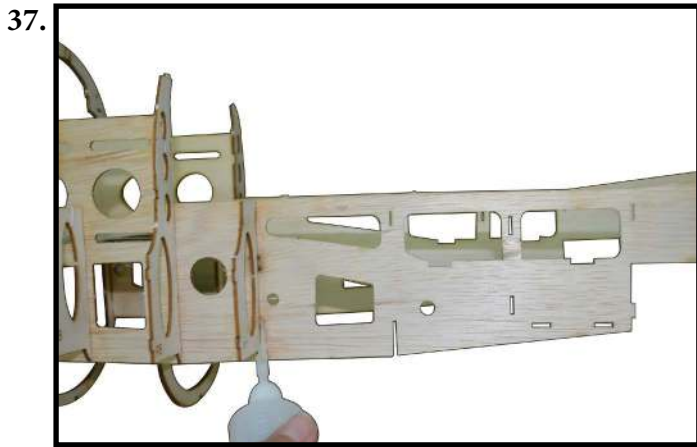

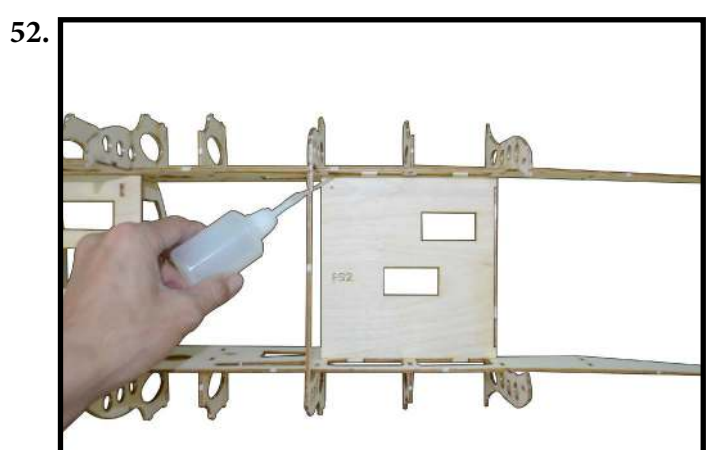
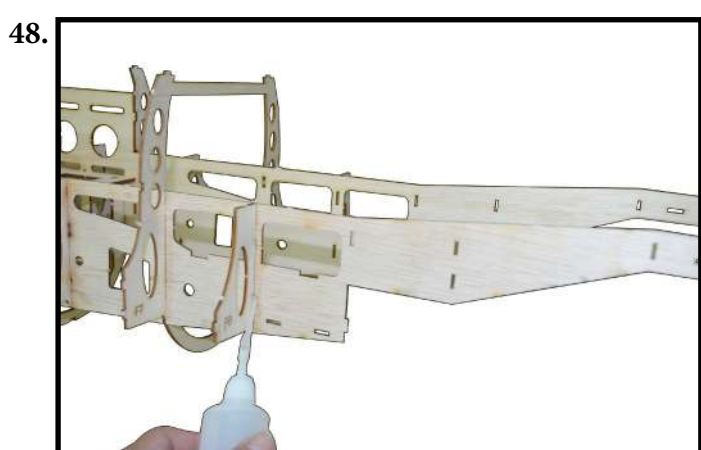
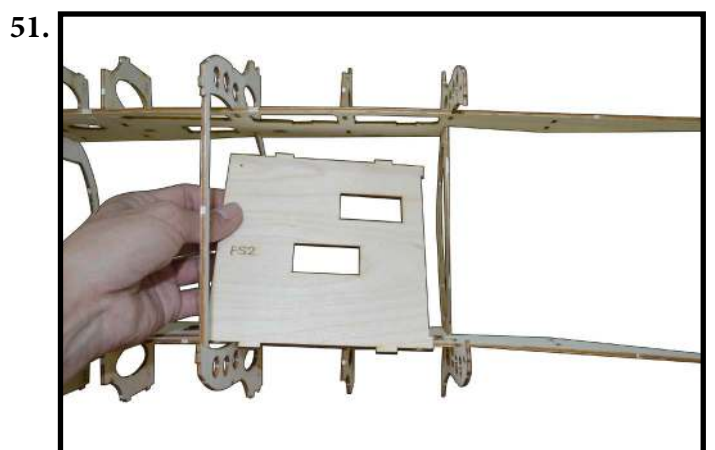
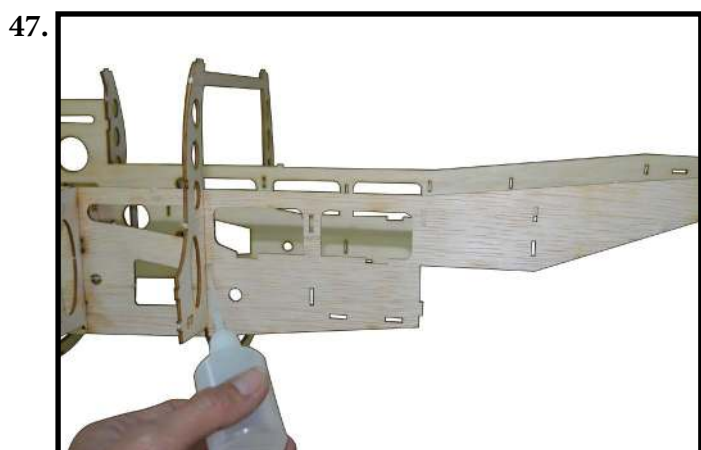
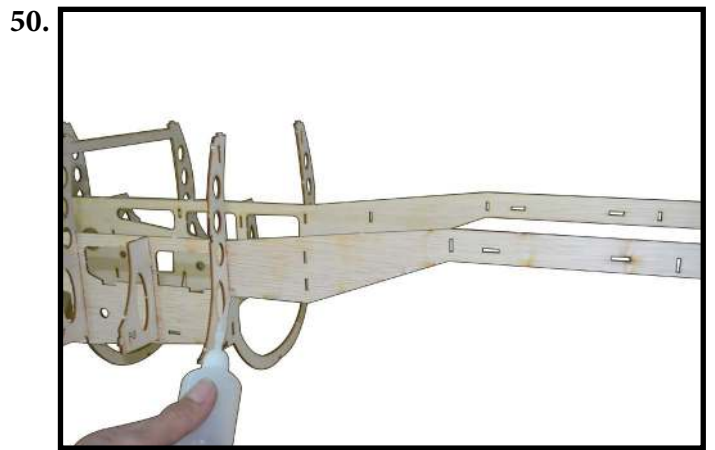
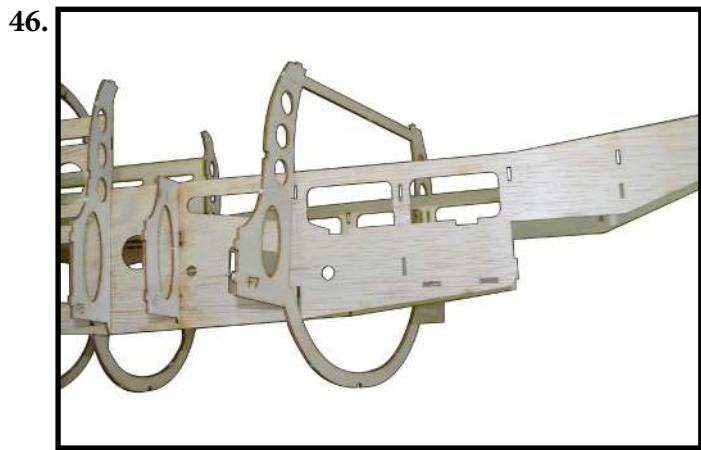
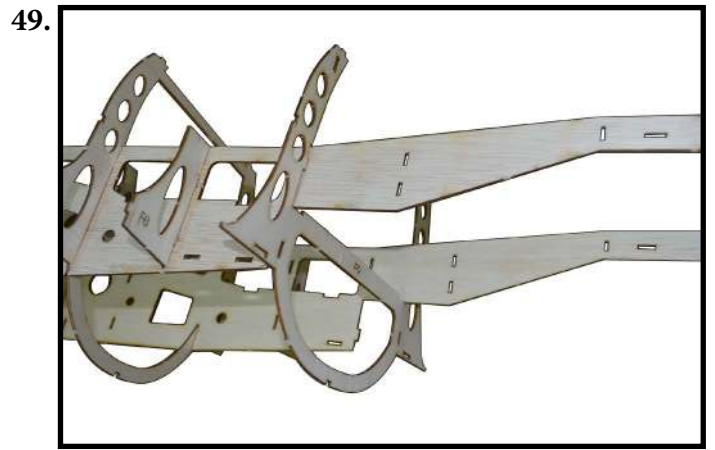
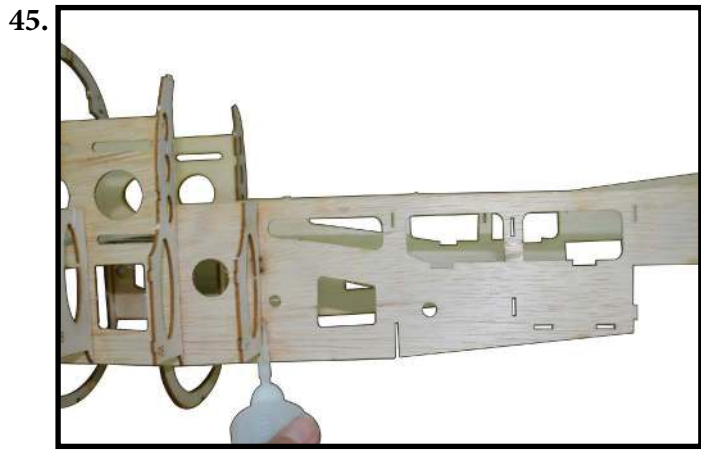

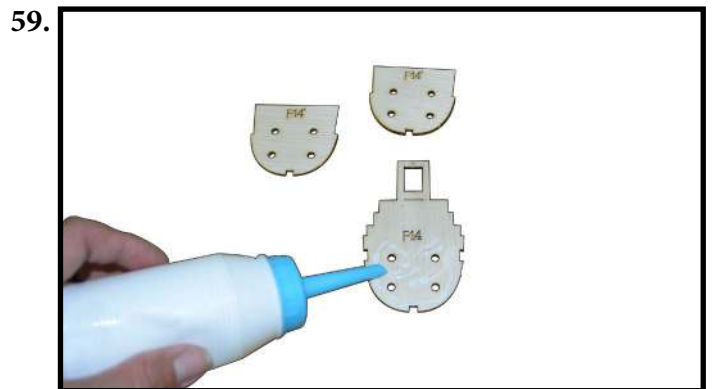
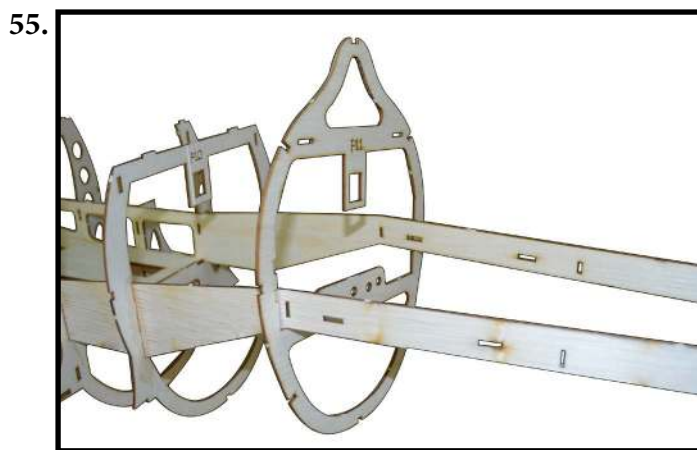
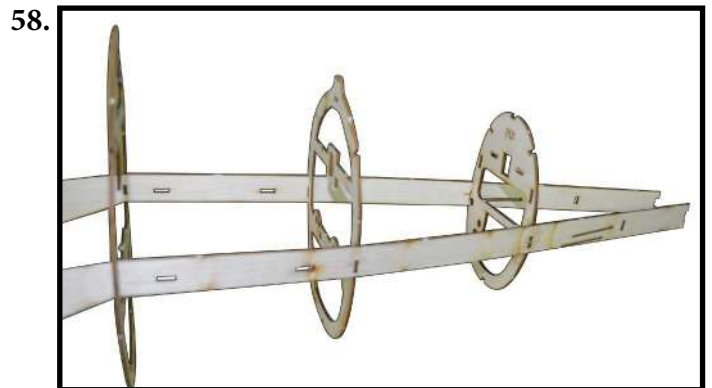
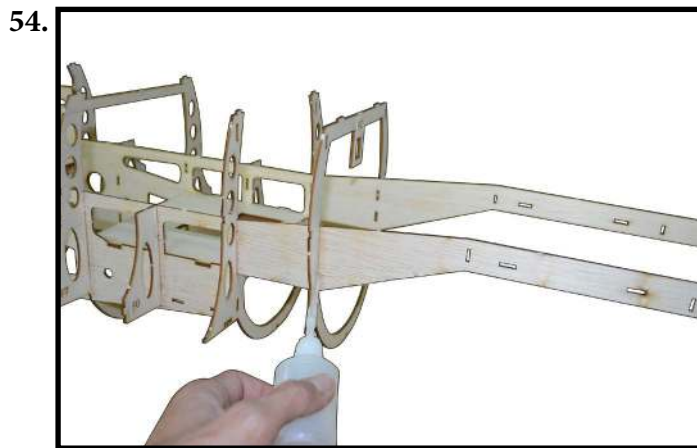
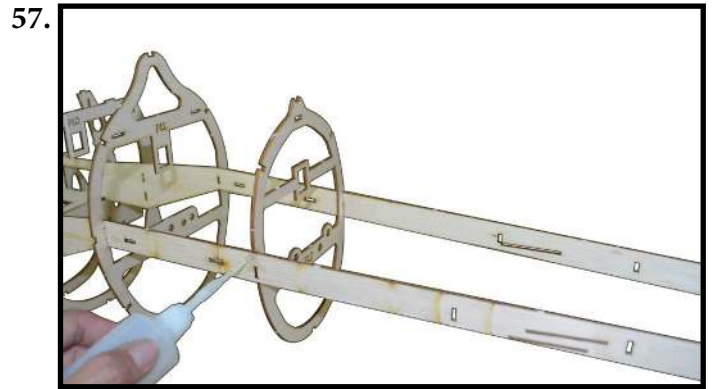
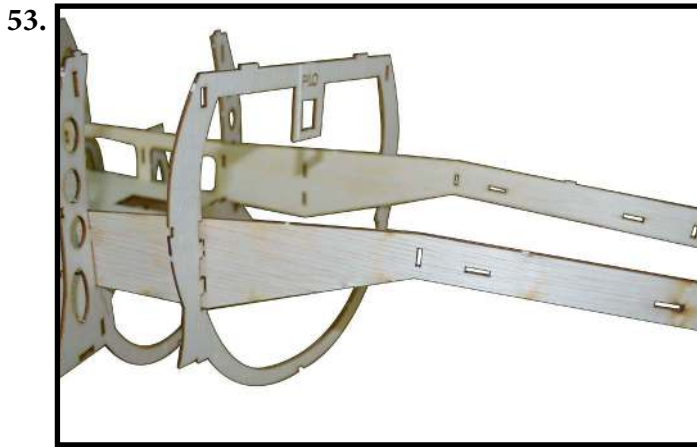

- Use White Glue to paste former F14' (2pcs) on former F14.

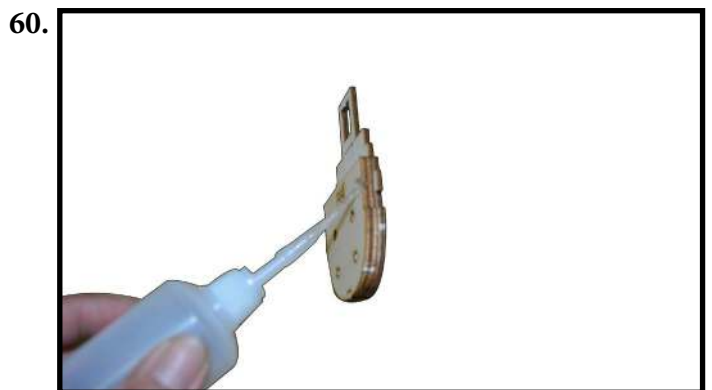
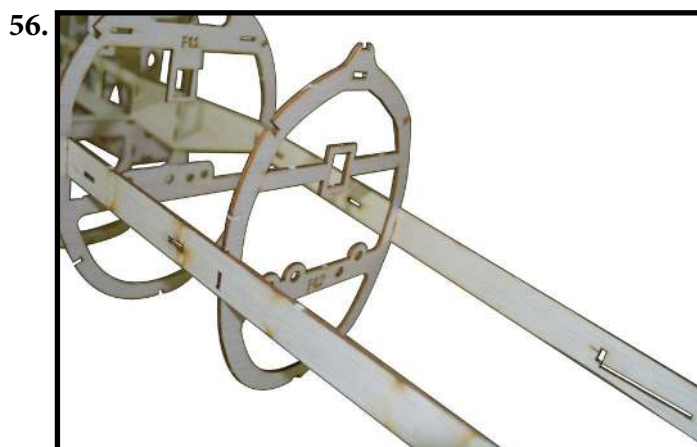

- Apply CA Glue around block include 3 layers former F14, F14'.

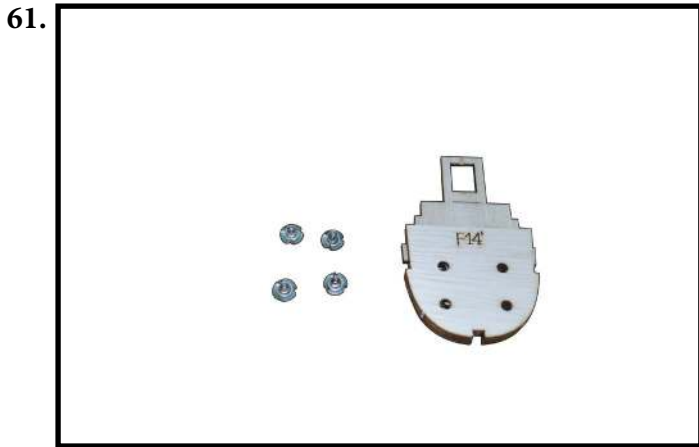

- Attach M3 blind nut (4pcs) to block of former F14, F14'.

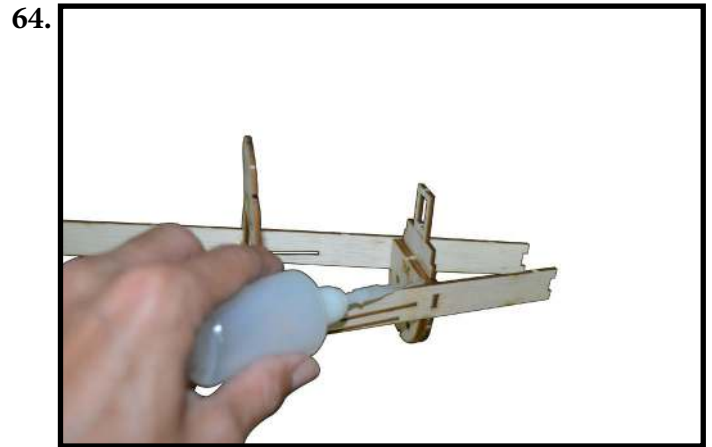

- Apply CA Glue to keep fixed block former F14, F14' with two side of fuselage.

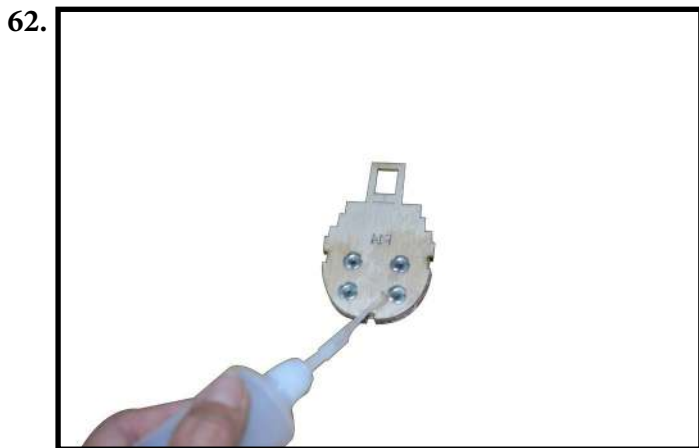

- Apply CA Glue around M3 blind nut (4pcs).

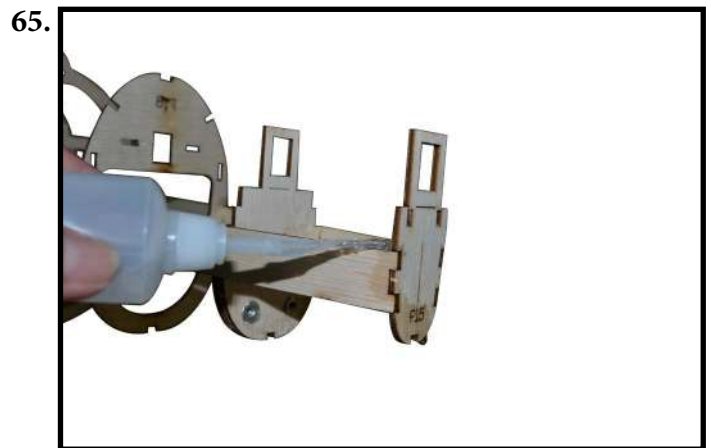

- Continue to install for the end former.

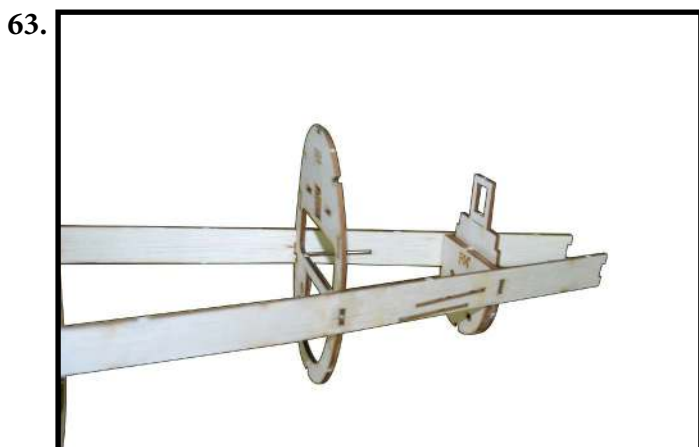

- Install block of former F14, F14' to the fuselage side.

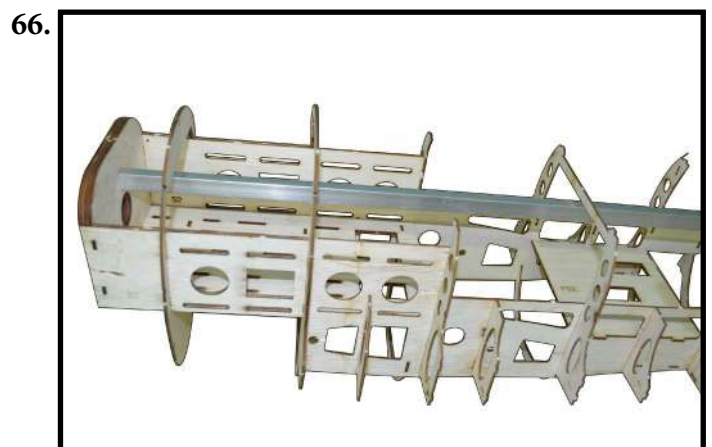

- Use Aluminium Square Fixed Tool to go through all formers at the square hole on each former.

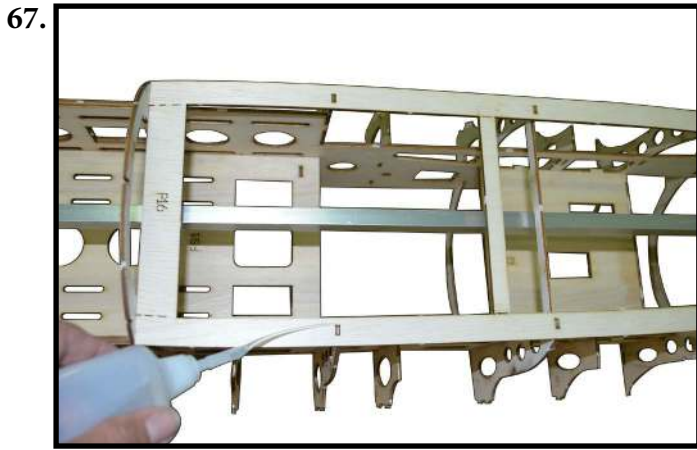

- Install F16 and apply CA Glue to keep fixed.

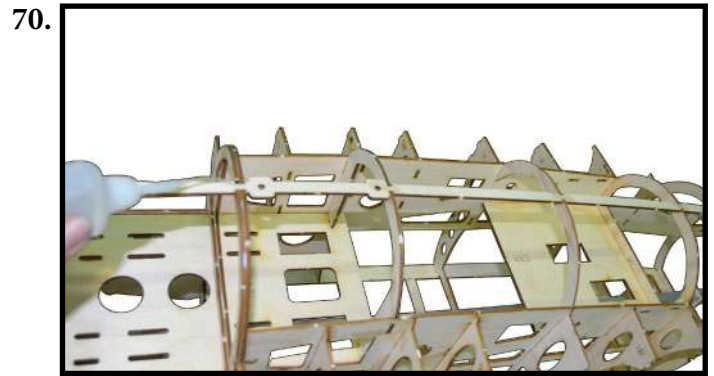

- Install F26 and apply CA Glue to keep fixed.

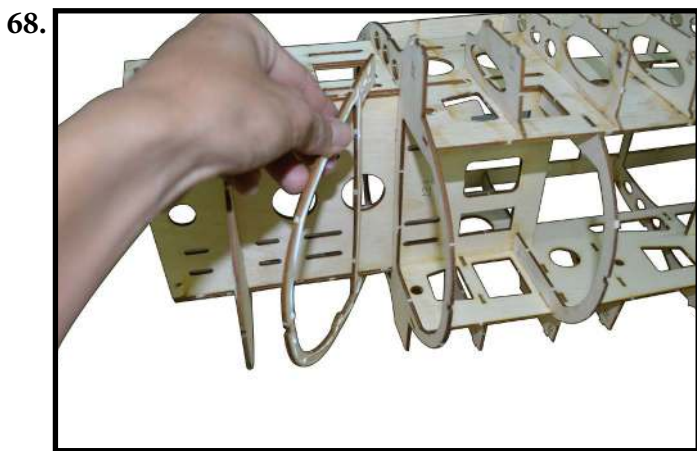

- Install F2' to F2 by White Glue.

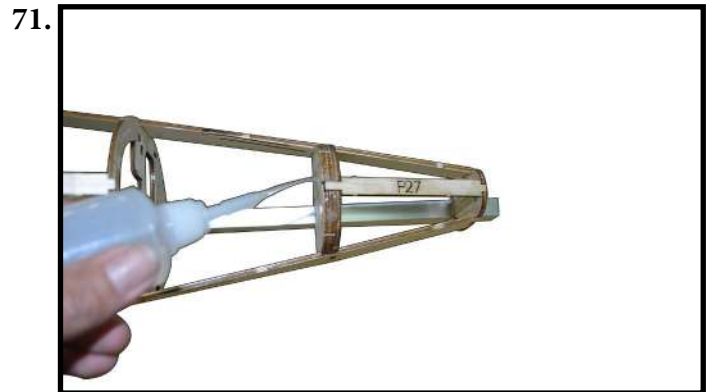

- Install F27 and apply CA Glue to keep fixed.

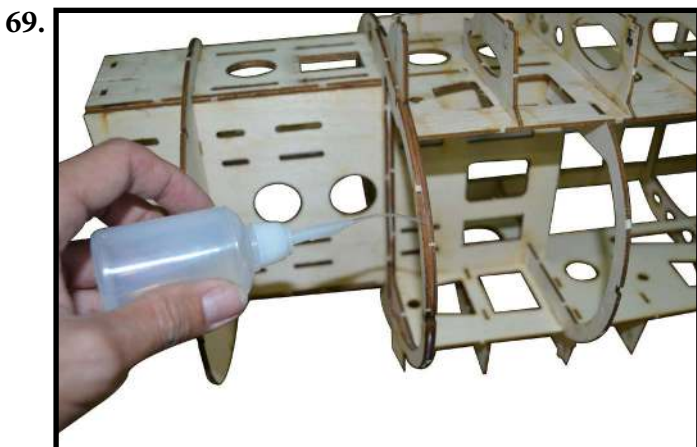

- Apply thin CA Glue around block include 2 layers former F2,F2'.

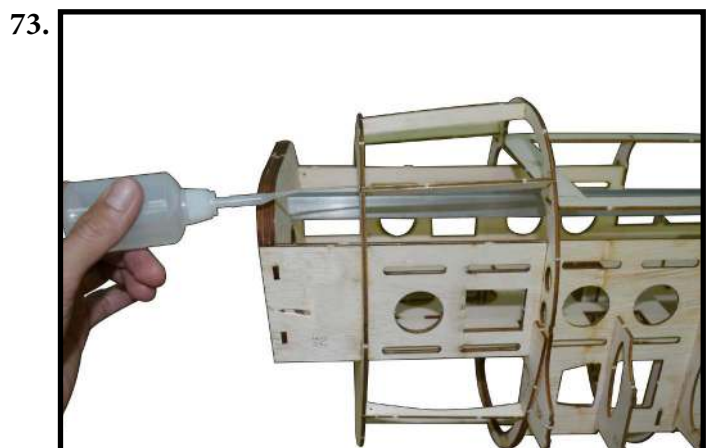
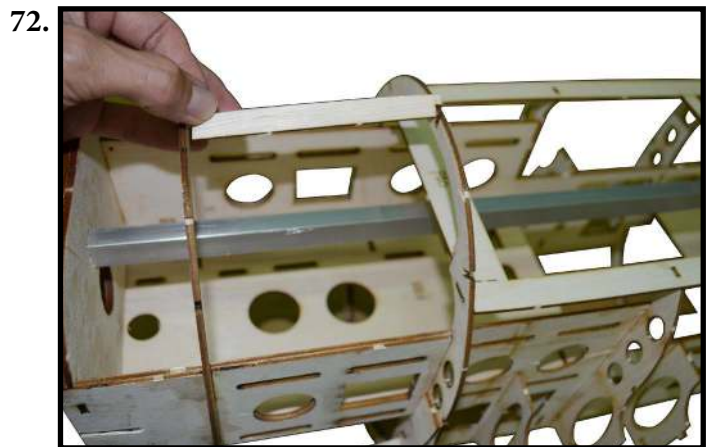

- Install F17 (3pcs) to fuselage and apply CA Glue to keep fixed. 77.

74.

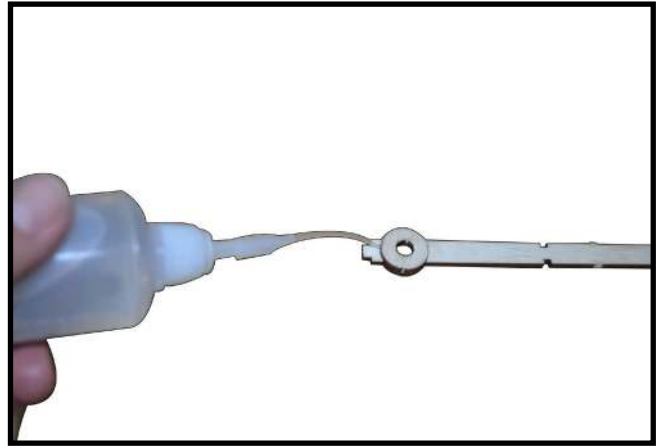

- Paste F19' on F19 by CA Glue.

- Install F18 (2pcs) to fuselage and apply CA Glue to keep fixed.

75.



78.

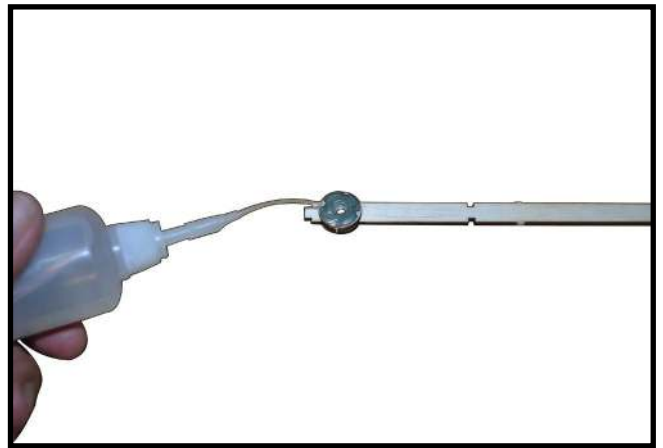

- Attach M4 blind nut to block of former F19, F19' and apply CA Glue around M4 blind nut.

- Install SW1 at right side and SW2 at left side, then apply CA Glue to keep fixed.

76.

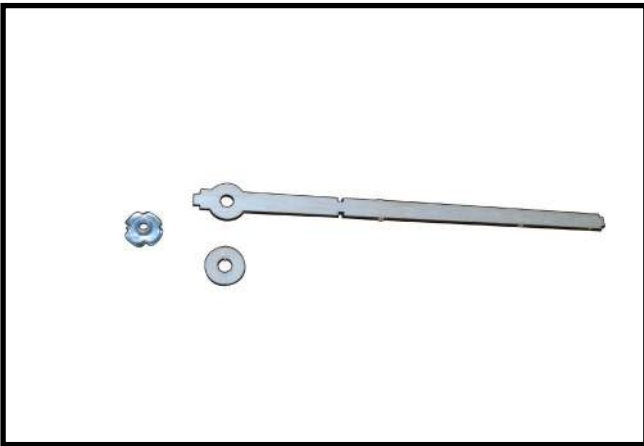

79.

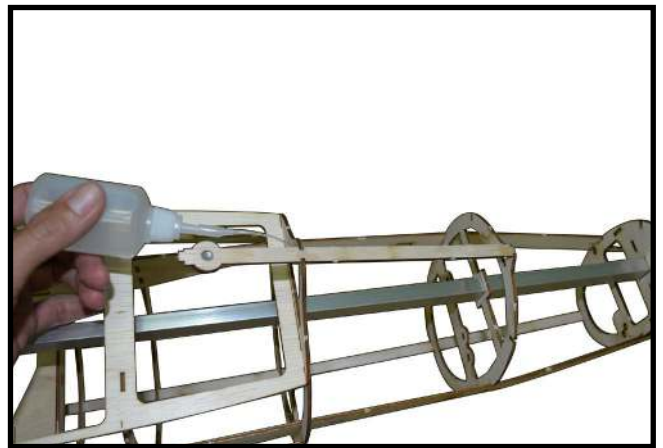

- Install block of former F19, F19' to fuselage and apply CA Glue to keep fixed.

- Getting prepare set of antenna include F19, F19' and M4 blind nut.

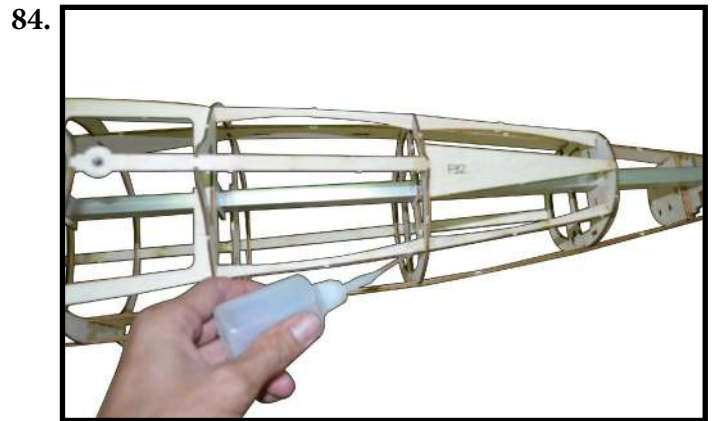
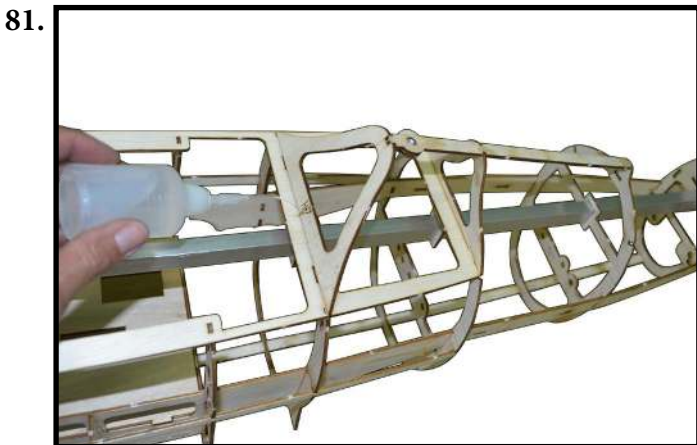
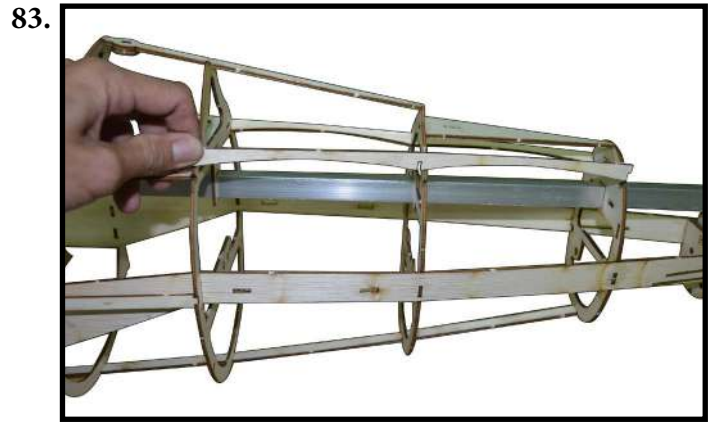
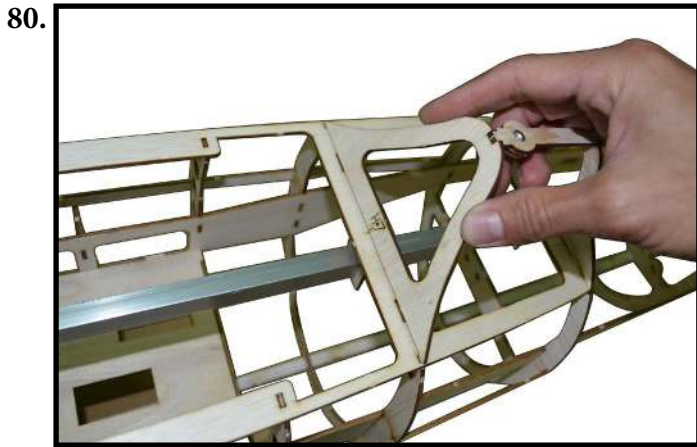

- Install H17 to fuselage and apply CA Glue to keep fixed.

- Install F20 (2pcs) to fuselage and apply CA Glue to keep fixed.

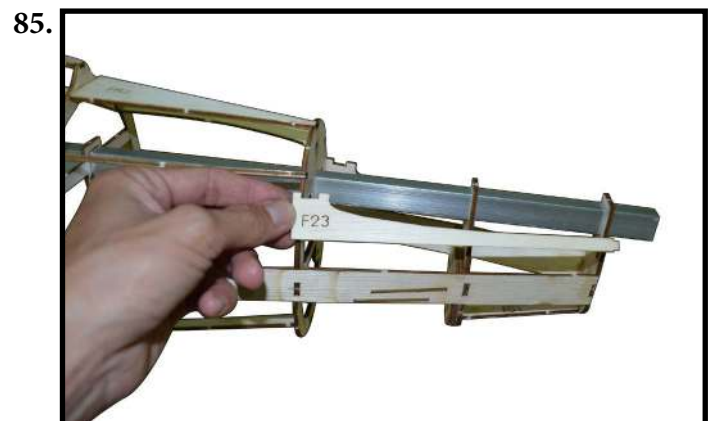
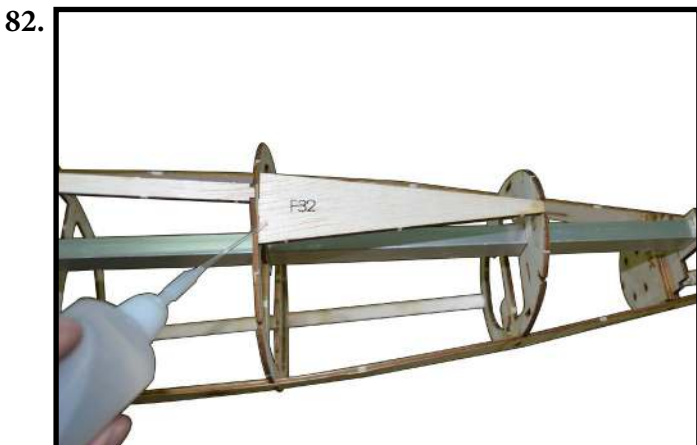

- Install F32 to fuselage and apply CA Glue to keep fixed.

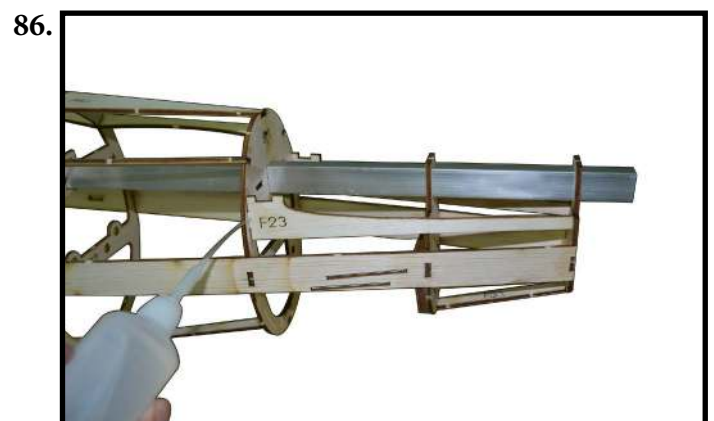

- Install F23 (2pcs) to fuselage and apply CA Glue to keep fixed.

87.

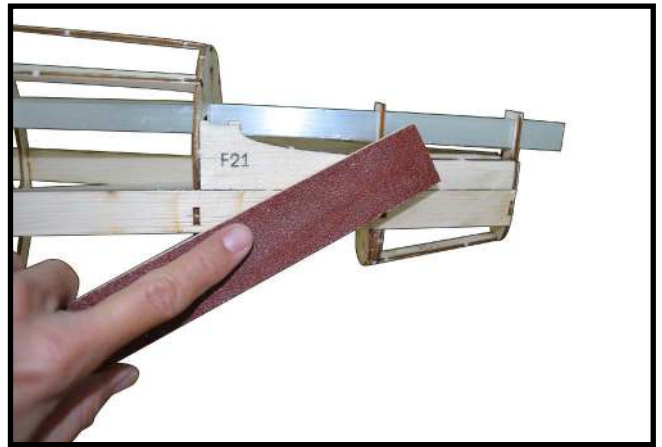
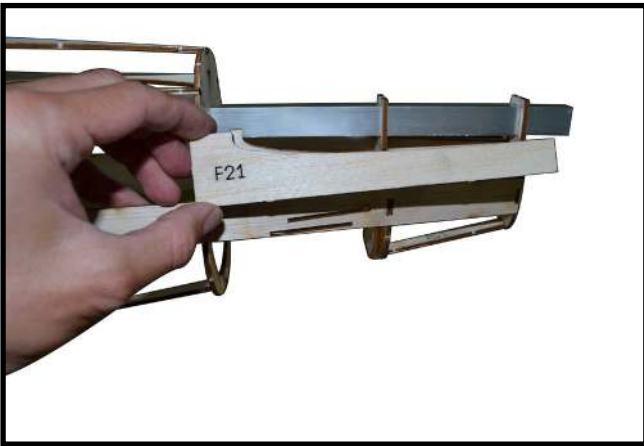

- Use sandpaper bar to sanding F21, so that making a flat with fuselage side.

88.

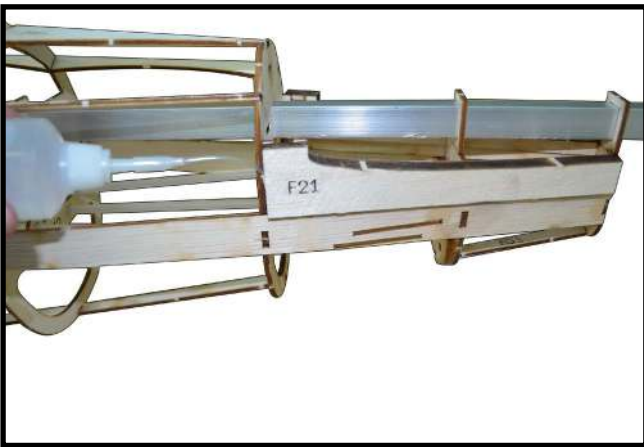

91.

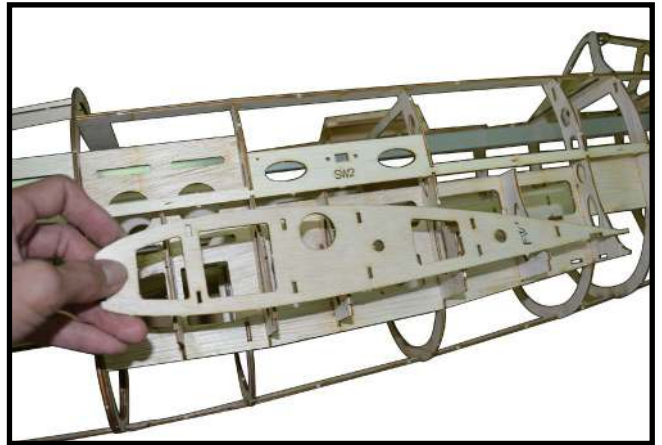

- Install F21 (2pcs) to fuselage and apply CA Glue to keep fixed.

89.

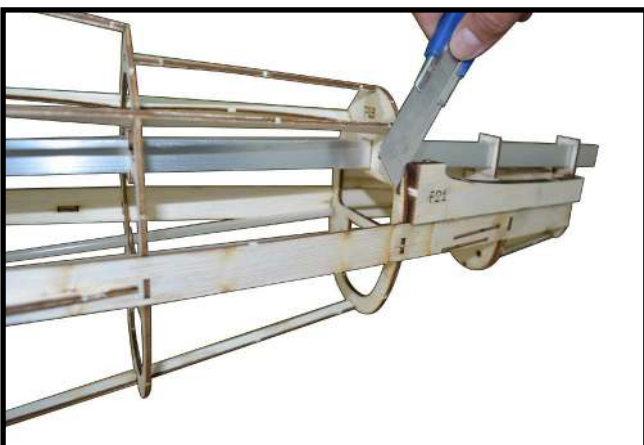

92.



- Install FW' to fuselage at right side and left side, then apply CA Glue to keep fixed.

- Use cutter knife cut off redundancy wood of F21.

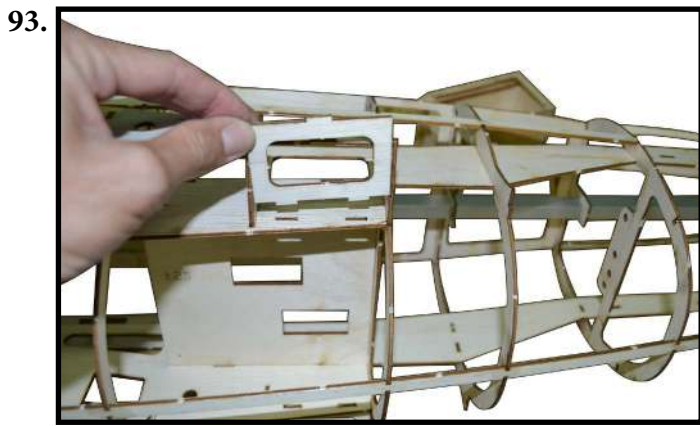

- Install F21' (2pcs) to fuselage at right side and left side and apply CA Glue to keep fixed.

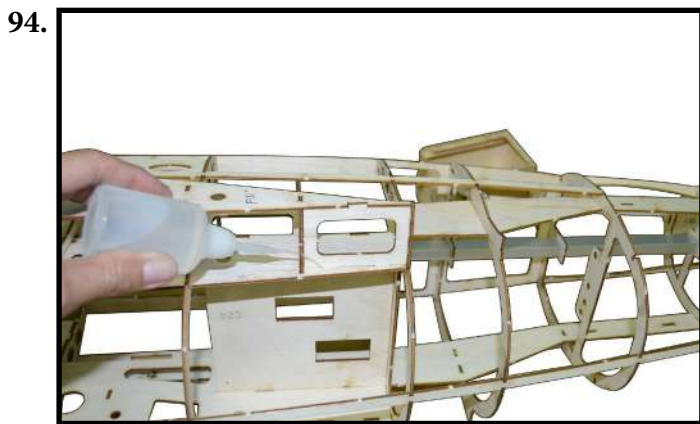

- Install F25' to fuselage at right side and left side, then fill CA Glue to keep fixed.

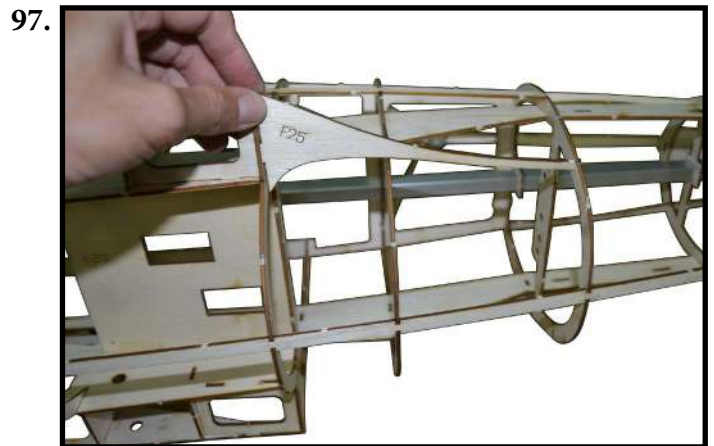
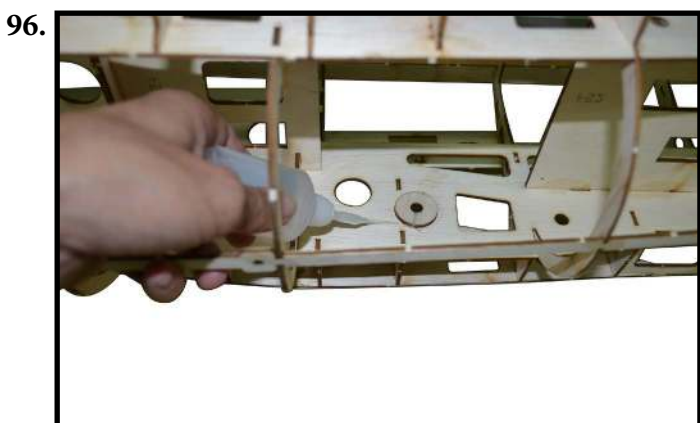
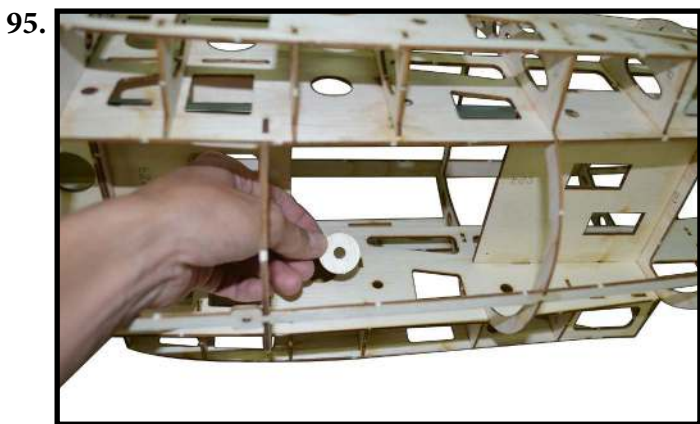

- Install F25 to fuselage at right side and left side, then apply CA Glue to keep fixed.

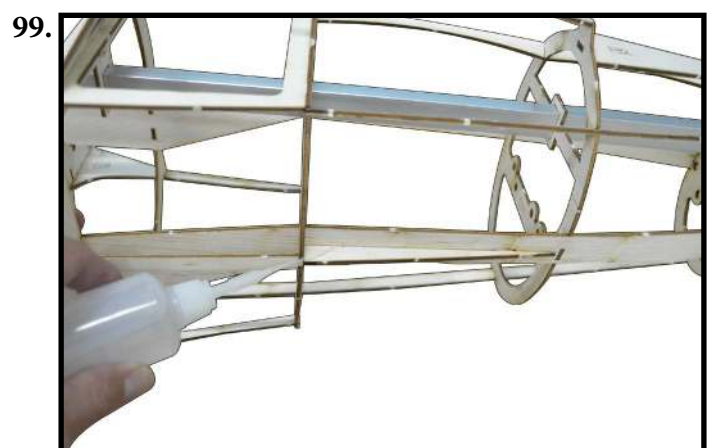
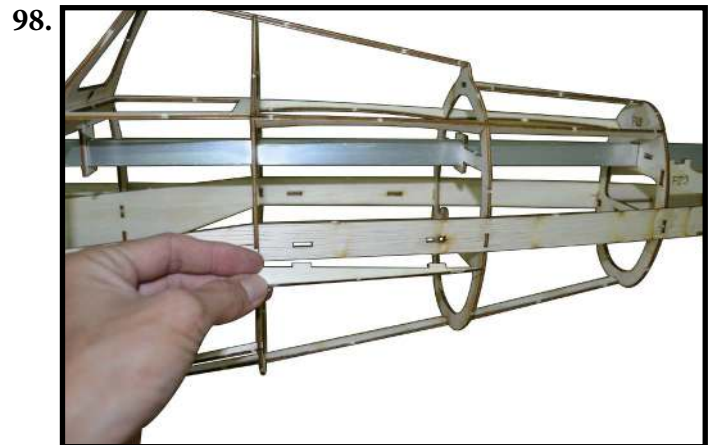

- Install F24 to fuselage at right side and left side, then apply CA Glue to keep fixed.

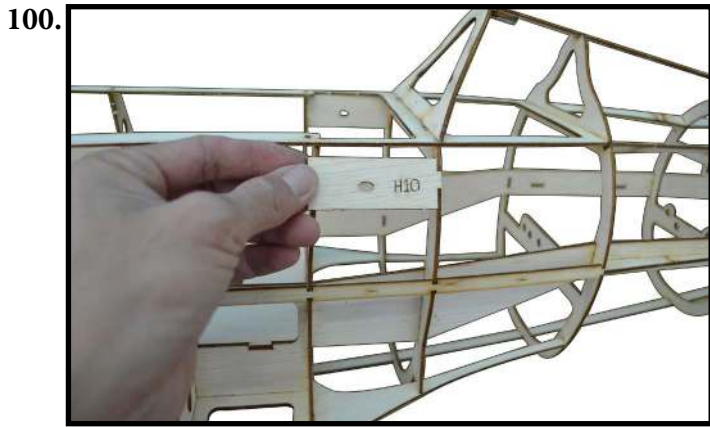

- Getting prepare the plastic tube (4pcs) with $\text{Ø} = 5\text{mm}$; 36cm length (photo 103).

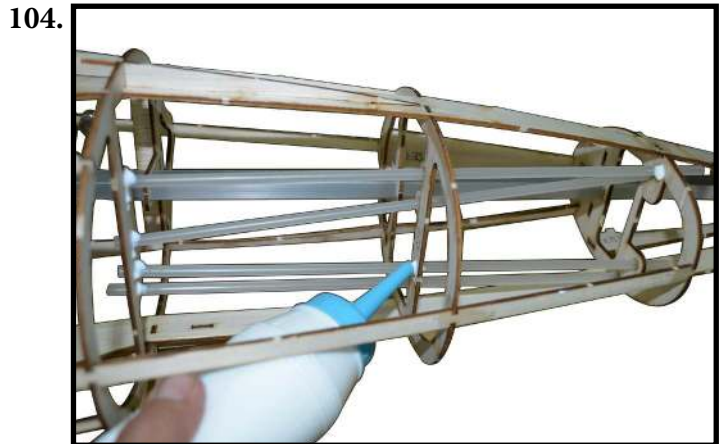
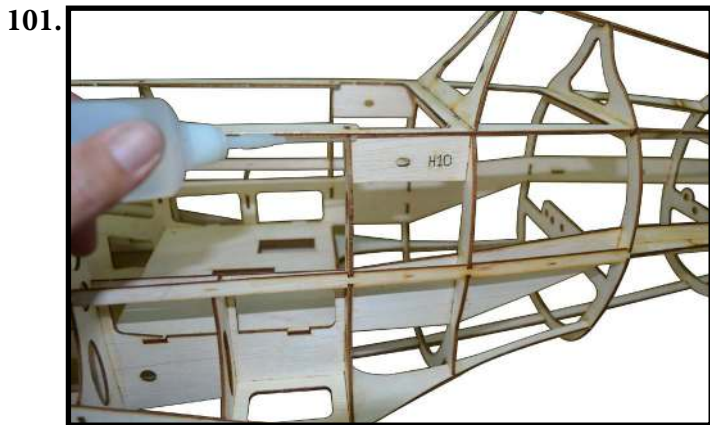

- The plastic tube to go through all formers which have path of Fin and path of Elevator hole on each former and fill White Glue to keep fixed.

Please kindly see in the drawing sheet so that avoiding mistake at this step.

- Install H10 to fuselage at right side and left side, then apply CA Glue to keep fixed.

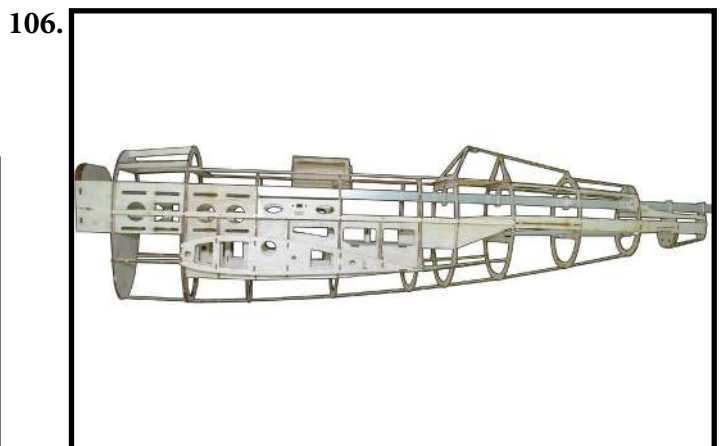
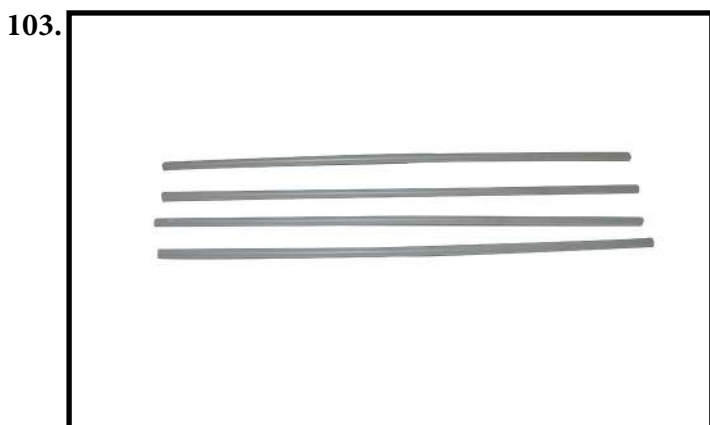
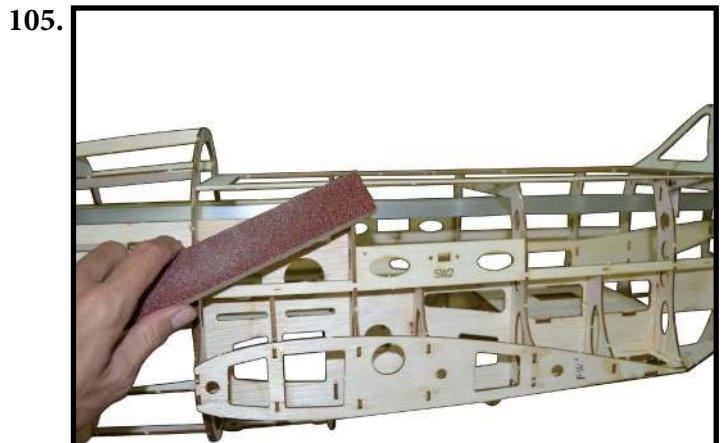

- Use sandpaper bar to sanding around the ribs of fuselage for cleaning convexness.

COVER TO THE RIBS OF FUSELAGE

If the balsa sheet quite hard, we should use the wet towel so that making soft the balsa sheet.

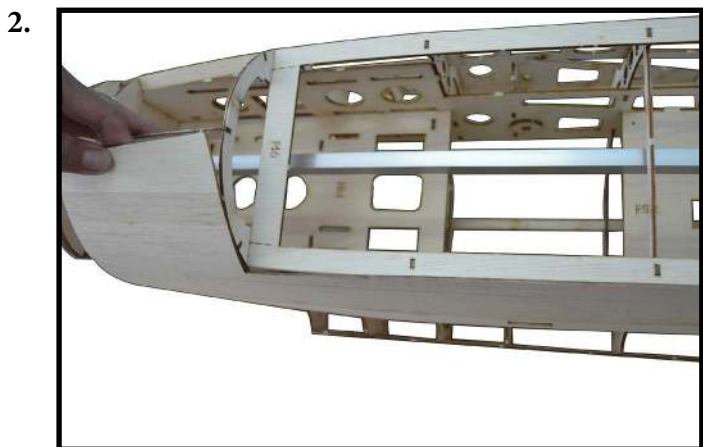

- Cover the sheet SH3 on ribs of fuselage at the left side.

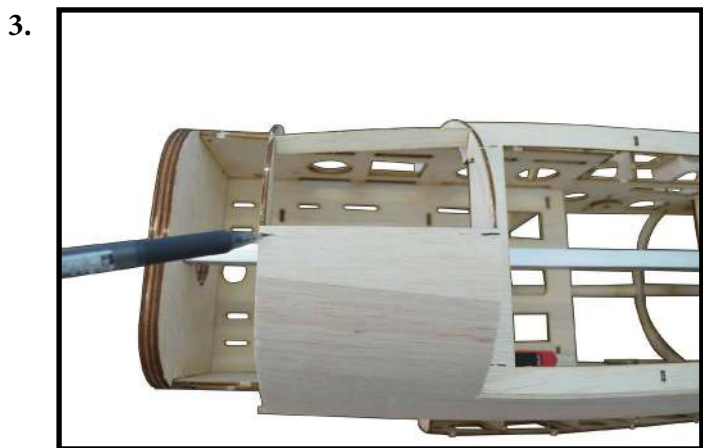

- Use the pen make mark at the center.

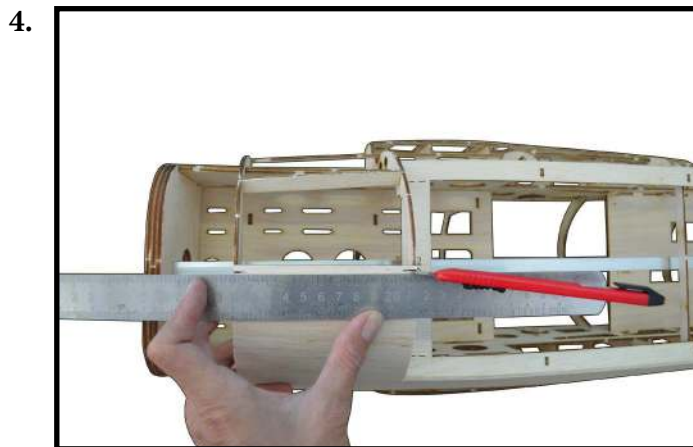

- Use cutter knife cut off redundancy of SH3.



- Cover the sheet SH4 on ribs of fuselage at the right side.

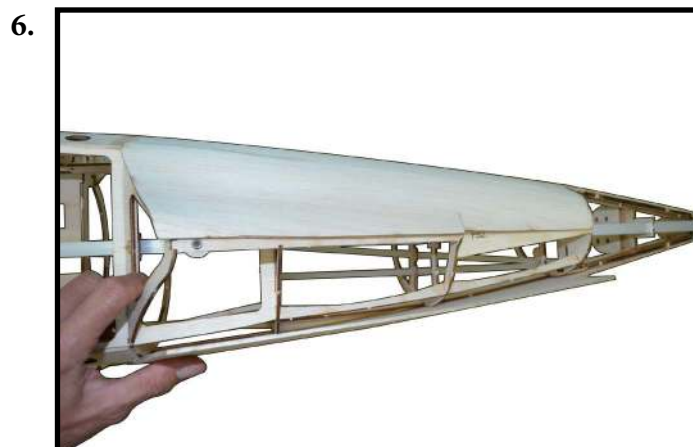

- Cover the sheet SH1 on ribs of fuselage at the right side.

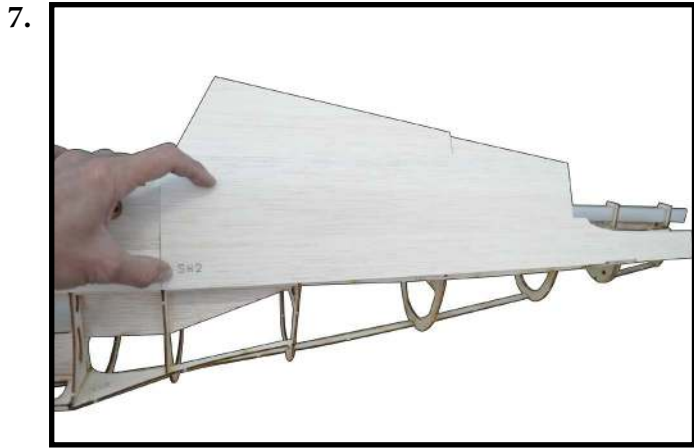

- Cover the sheet SH2 on ribs of fuselage at the left side.

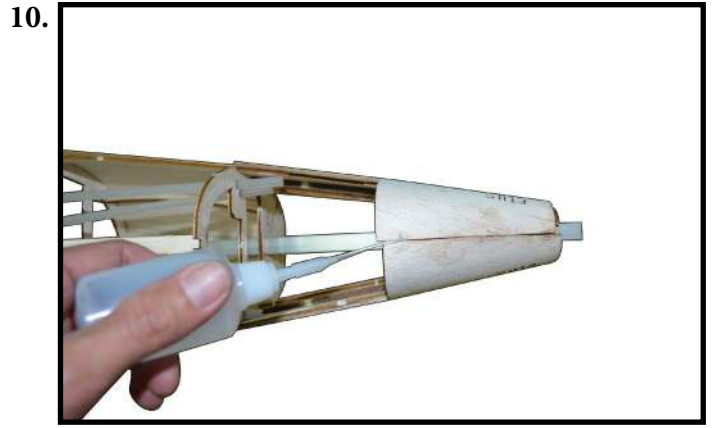

- Cover the sheet SH14 on ribs of fuselage at the right side.

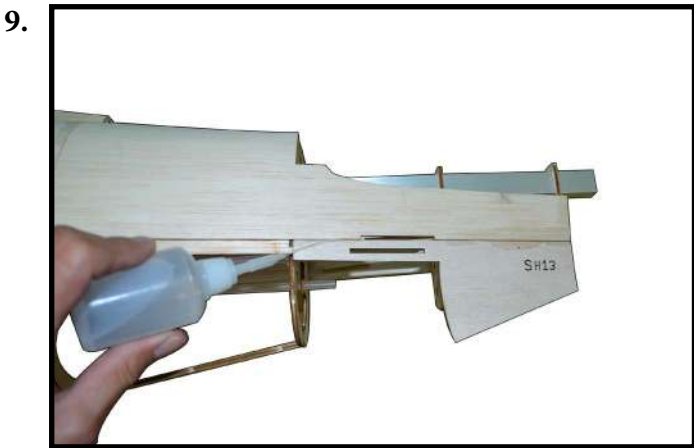
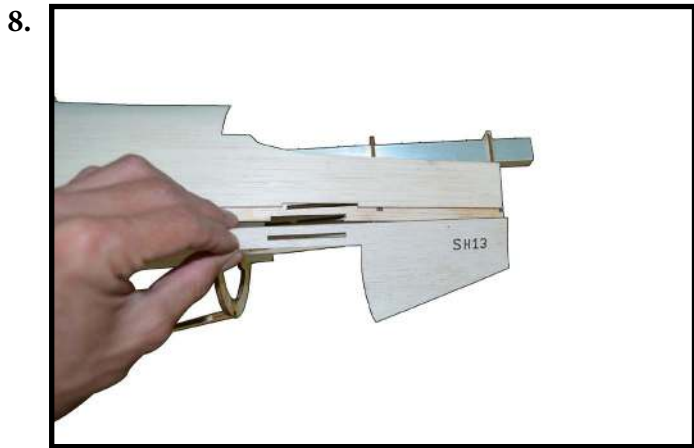

- Cover the sheet SH13 on ribs of fuselage at the left side.

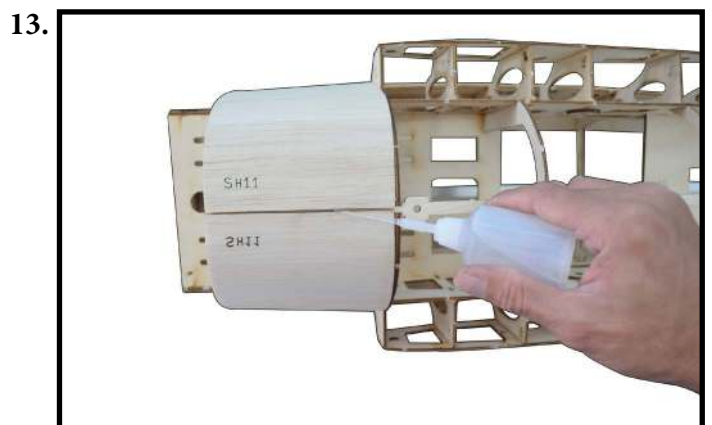
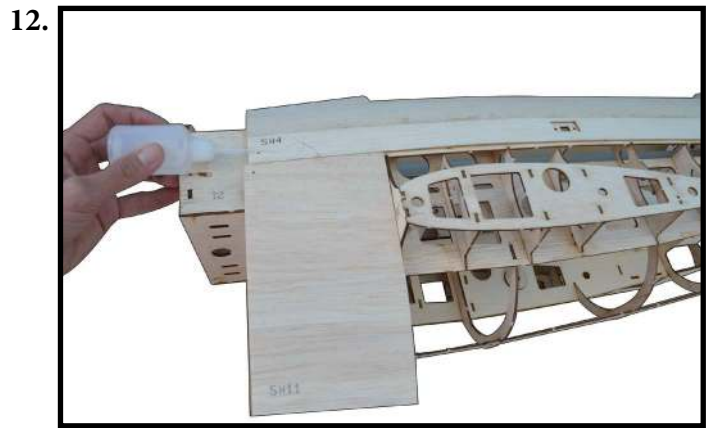
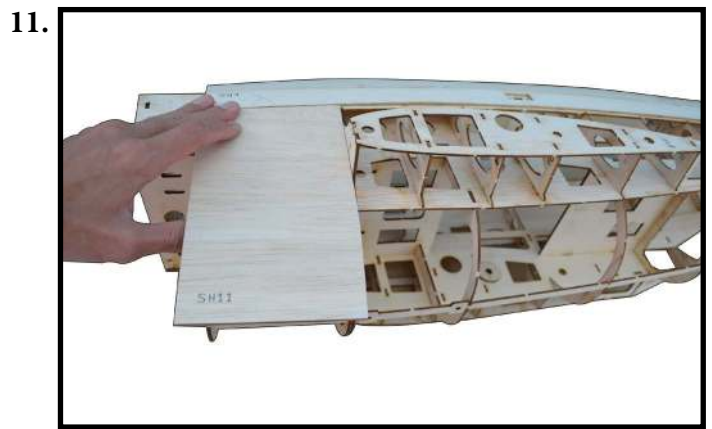

- Cover the sheet SH11 on ribs of fuselage at the both of side.



- Cover the sheet SH7 on ribs of fuselage at the both of side.

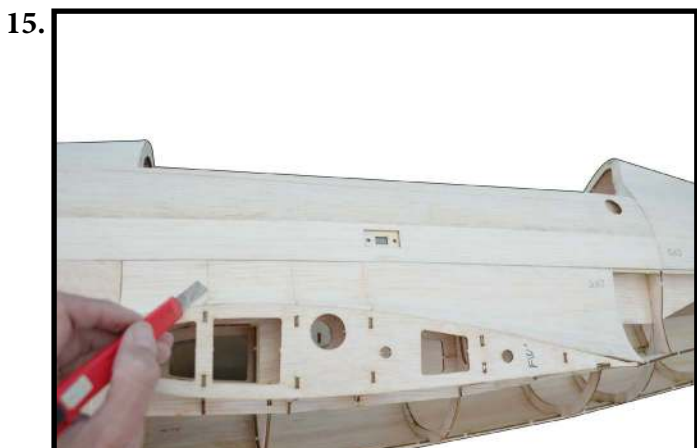

- Use cutter knife cut SH7 at position of the formers so that bending the sheet easily.



- Apply CA Glue at position of the crack on the sheet SH7.



- Cover the sheet SH12 on ribs of fuselage at the both of side.



- Apply CA Glue to keep fixed the sheet SH12.

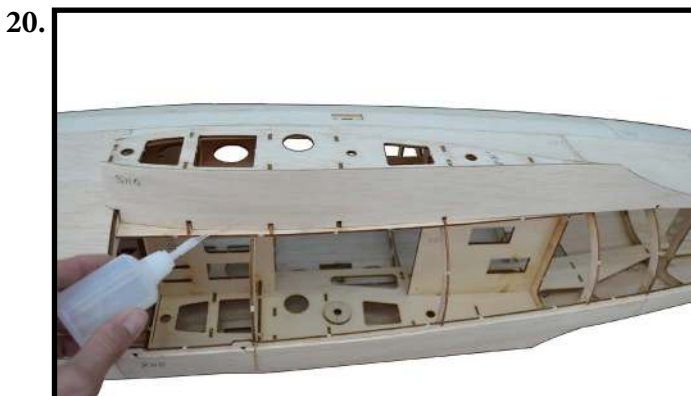
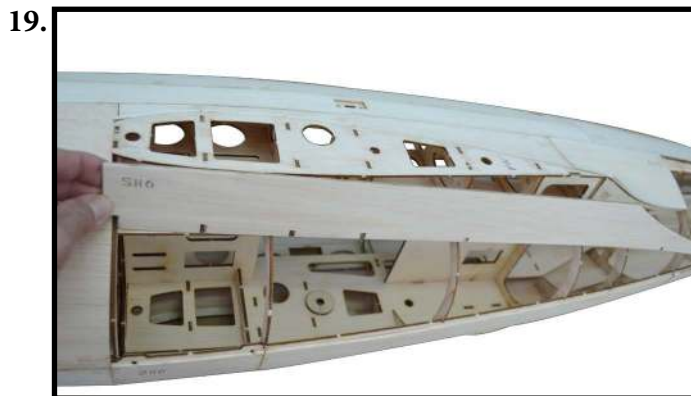

- Cover the sheet SH6 on ribs of fuselage at the both of side apply CA Glue to keep fixed.

21.



- Cover the sheet SH5 on ribs of fuselage at the both of side.

22.

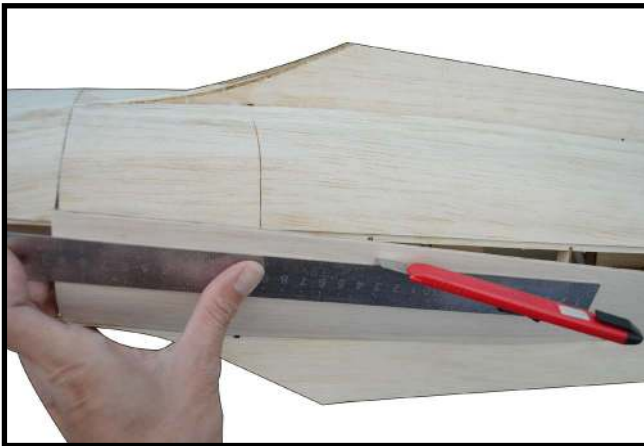

- Use the pen make mark at the center and then use Cutter knife to cut off redundancy of SH5.

23.

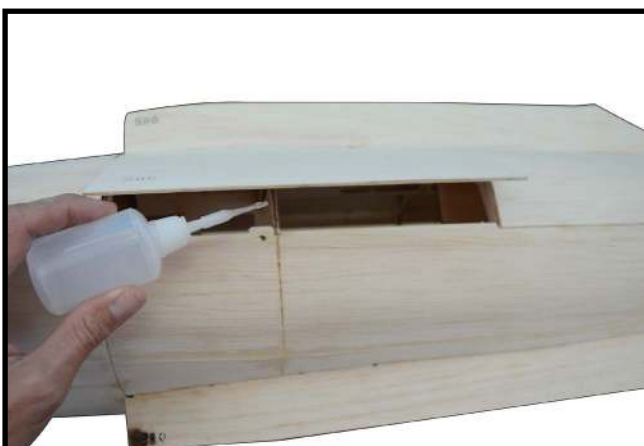

- Apply CA Glue to keep fixed the sheet SH5.

24.

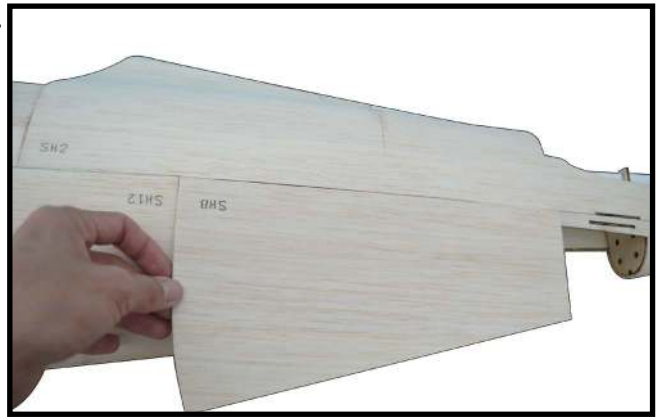

25.

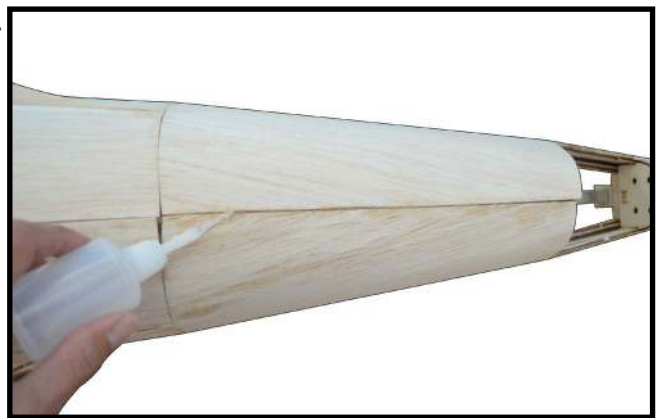

- Cover the sheet SH8 on ribs of fuselage at the both of side and apply CA Glue to keep fixed the sheet SH8.

26.



27.



- Install F30 and F31 (8mm balsa wood) to fuselage and apply CA Glue to keep fixed.

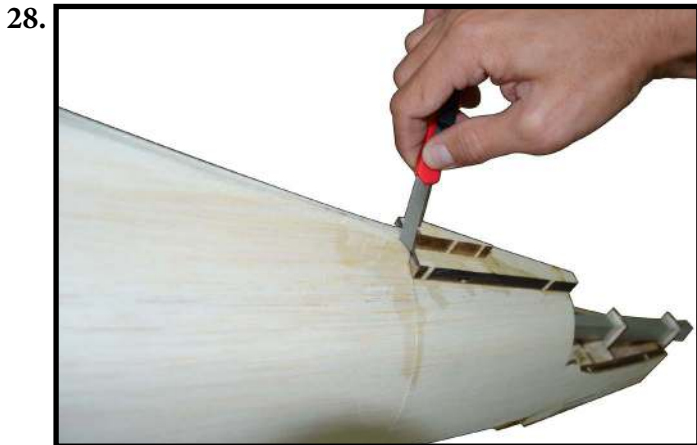

- Use cutter knife to cut off redundancy wood of F31.



- Use sandpaper bar to sanding block include F30 and F31, making flat with fuselage side.



- Install FW to fuselage at right side and left side, then apply CA Glue to keep fixed.

Should use the wing as instruction photo so that installing FW exactly as photo.

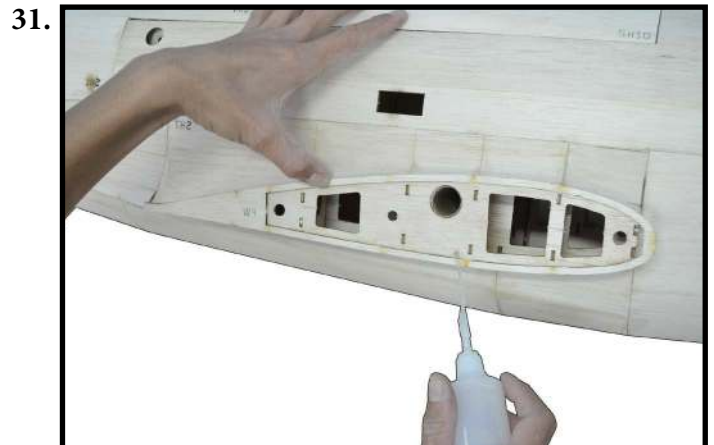

- Apply CA Glue to keep fixed FW.

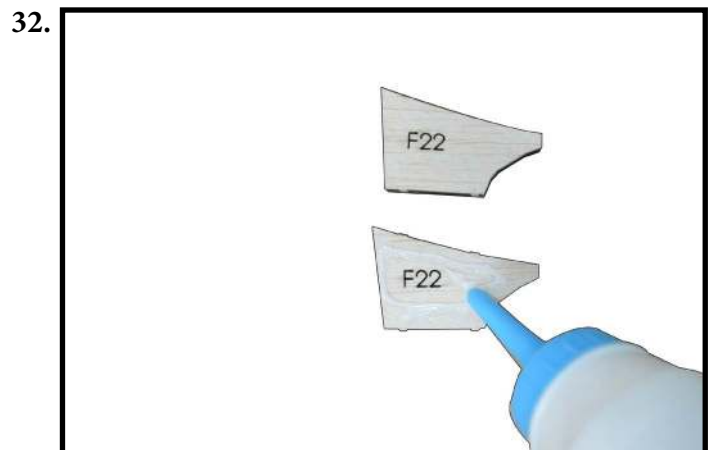

- Apply white Glue to the surface of the 1st F22 (8mm) and paste on the 2nd F22 (8mm).

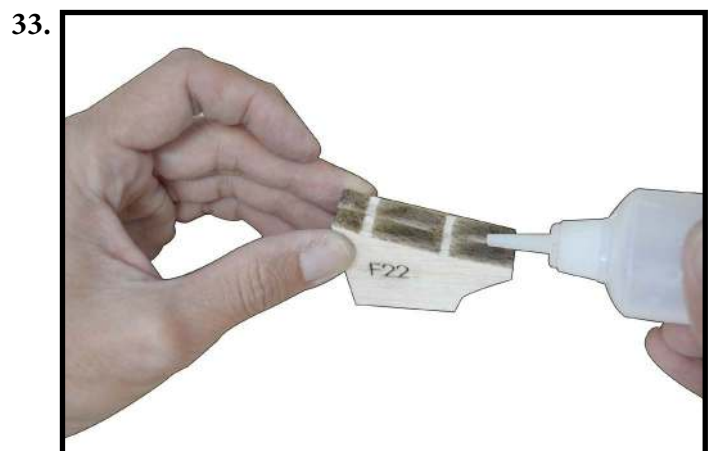

- Apply CA Glue around 16mm block F22.



- Install 16mm block F22 to the fuselage by White Glue.

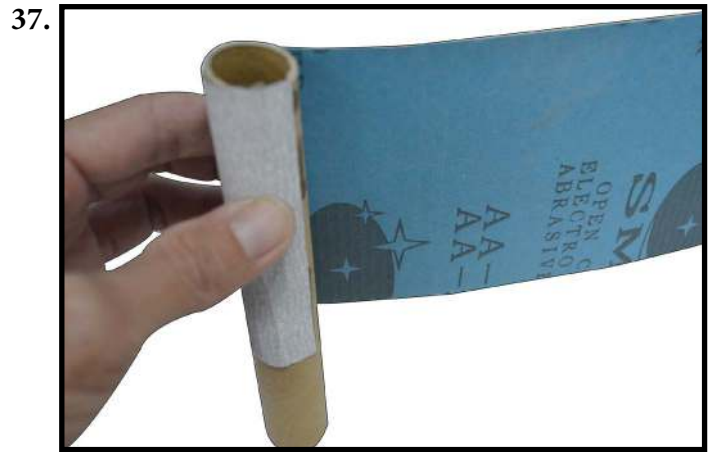

- Roll sandpaper around the paper tube so that making a sandpaper tube.



- Apply CA Glue to keep fixed 16mm block F22 sticky more.

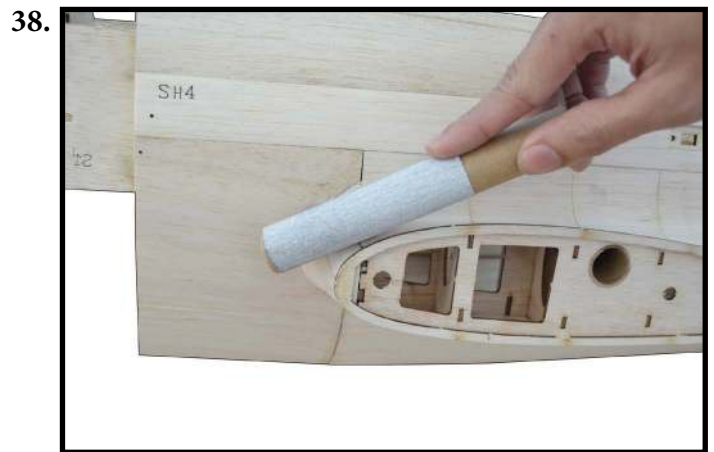

- Sanding wood block F22 so that shaping the wing fillet.

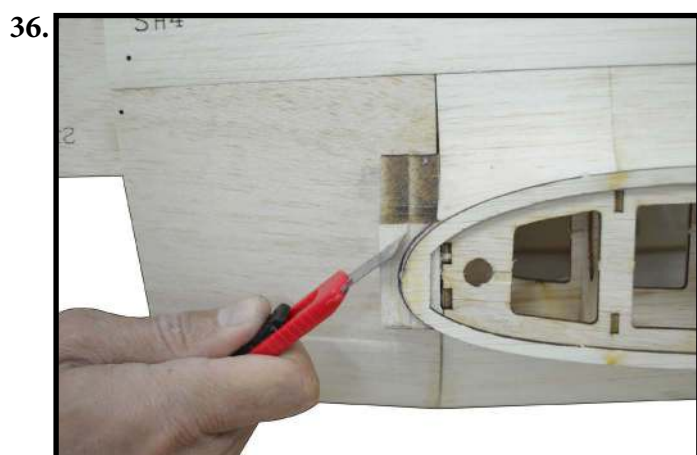

- Use cutter knife to cut off redundancy wood of 16mm block F22 as photo.



- Use countersink with $\text{Ø} = 4\text{mm}$, to drill the hole for antenna at the top of fuselage as photo.

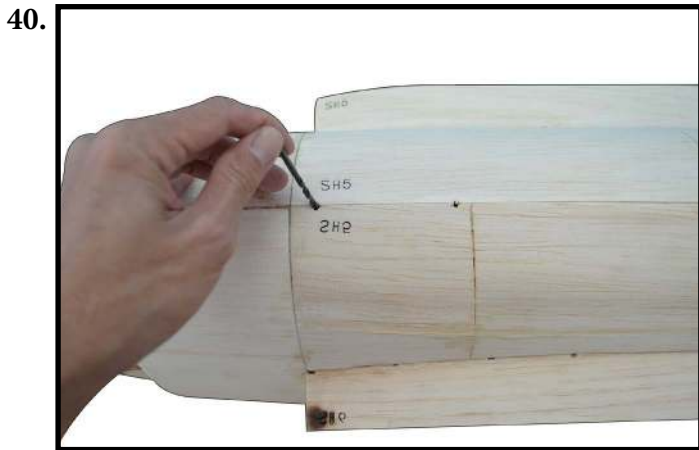

- Use countersink with $\text{Ø} = 3\text{mm}$, to drill the hole for bomb at the bottom of fuselage as photo.

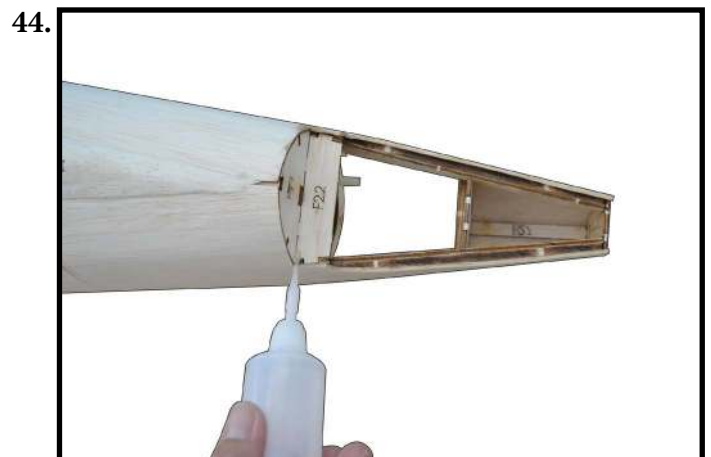
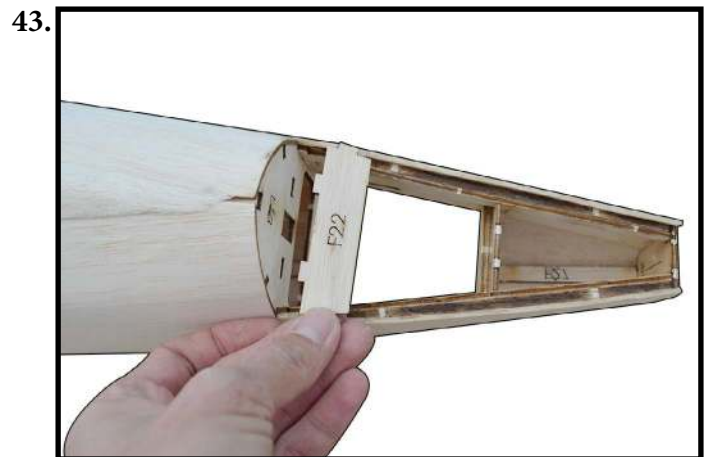

- Install F22 to fuselage and apply CA Glue to keep fixed.



- The fuselage was finished.



- Use sandpaper bar to sanding at the end of fuselage (F15).

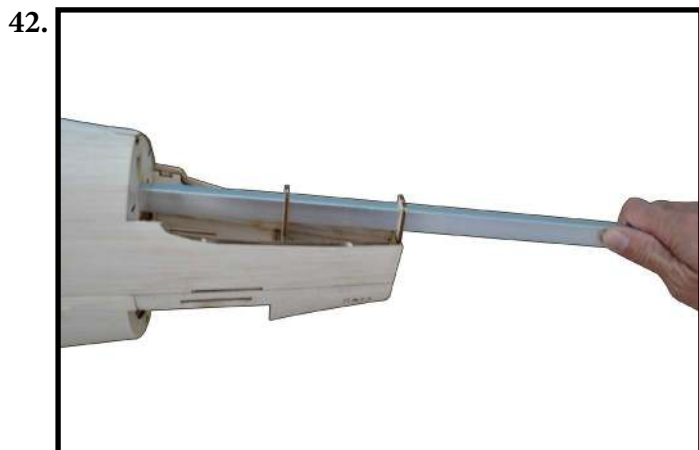

- Remove aluminium square fixed tool.

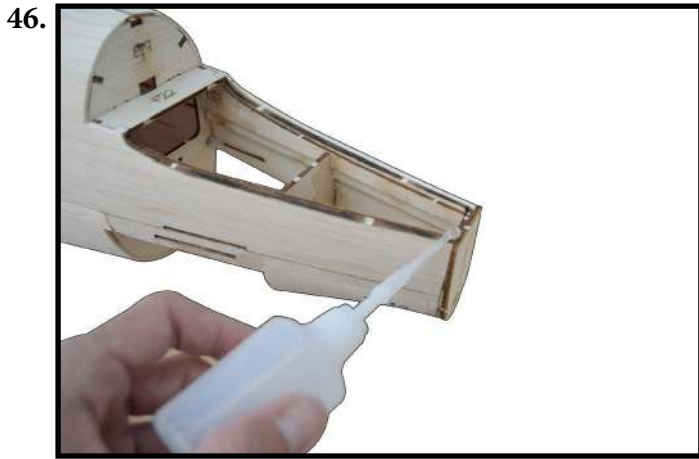

- Paste F15' on the end of fuselage at F15 by CA Glue.

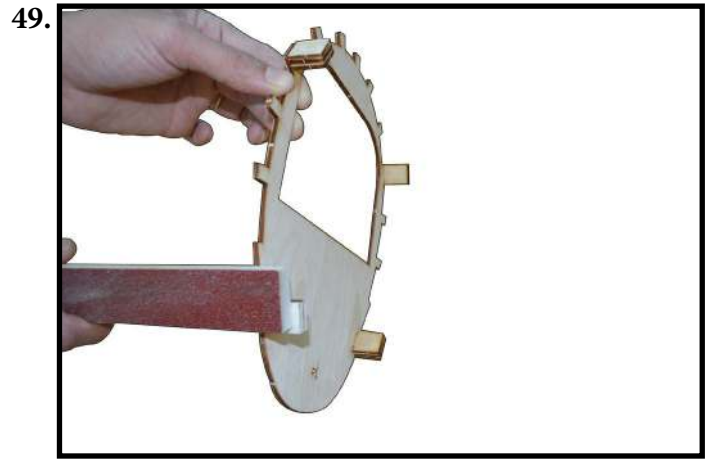

- Use sandpaper bar to sanding at block of tab as photo.

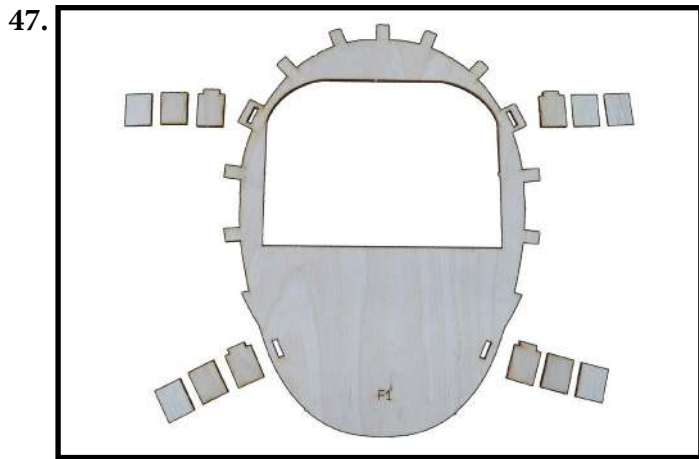

- Getting prepare set of cowling mount include set of tap (4set) and F1'.

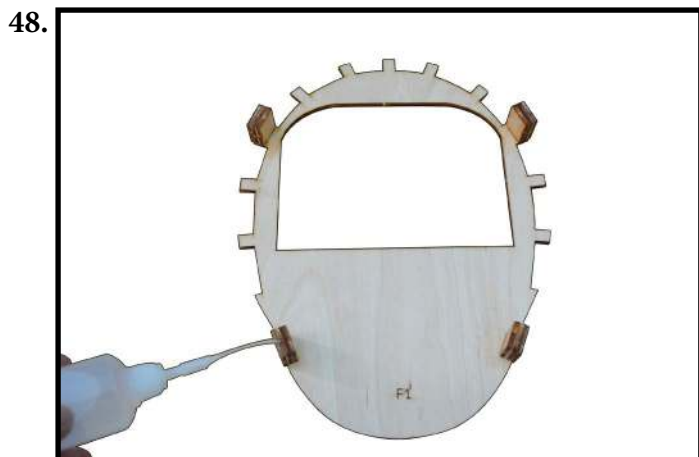
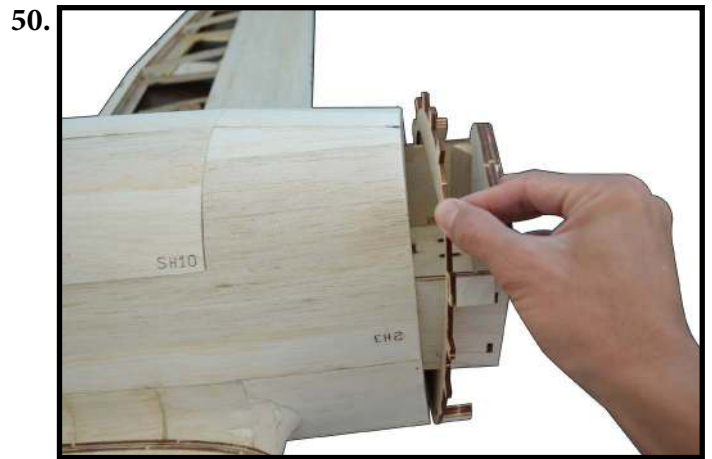

- Paste the tap together as photo and then install to F1' by CA Glue.

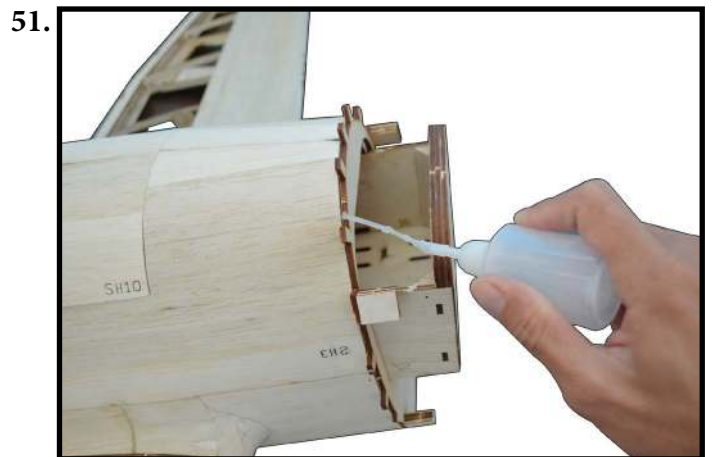

- Install F1' to fuselage and fill CA Glue to keep fixed.

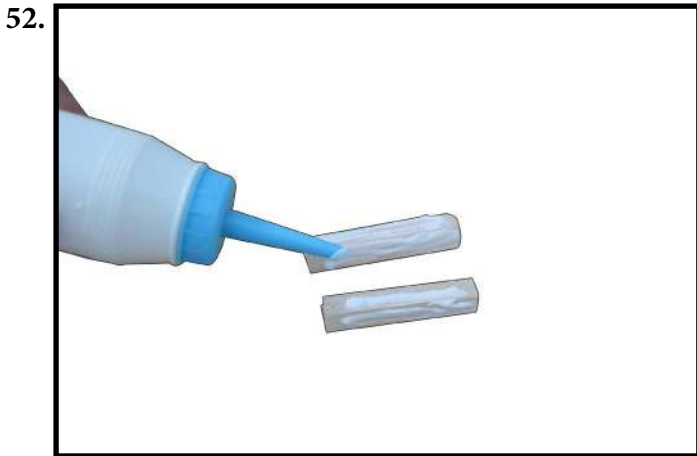

- Apply white Glue to the surface of the triangle block as photo.

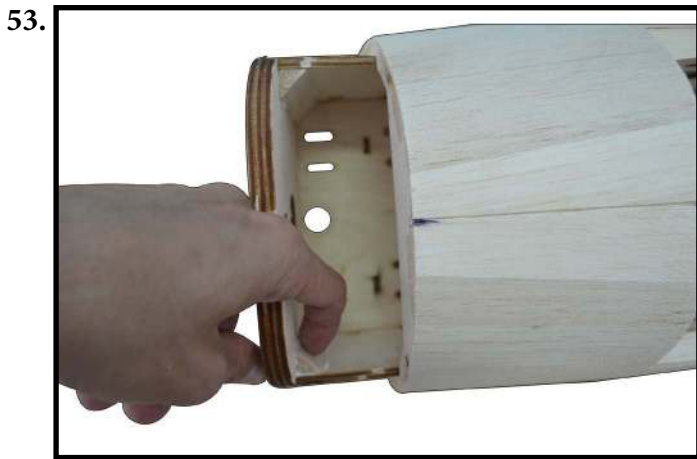

- Install triangle block (2 pcs) to fuselage as photo.



- Install paper tube to fuselage as photo.



- Apply white Glue to keep fixed paper tube.

INSTALLING THE FUSELAGE SERVOS

 Because the size of servos differ, you may need to adjust the size of the precut opening in the mount. The notch in the sides of the mount allow the servo lead to pass through.

- Install the rubber grommets and brass collets into all servos. Test fit the servos into the fuselage servo mounts.

- Secure the servos with the screws provided with your radio system.

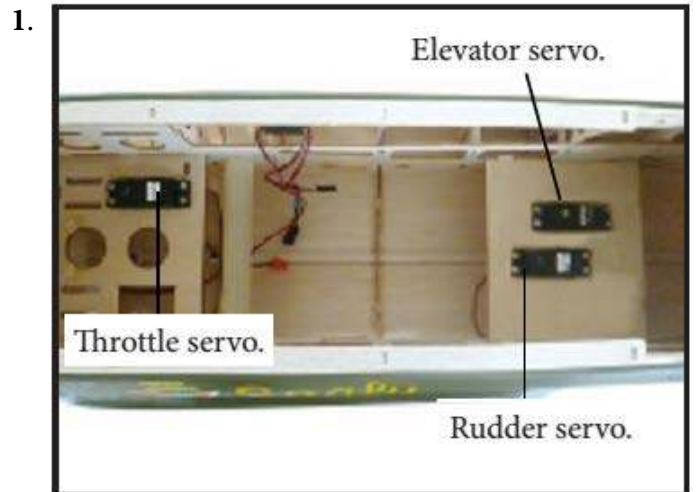

Minimum servo spec.
Torque : 80 oz-in (5.8 kg-cm) @ 4.8V; 100 oz-in (7.2 kg-cm) @ 6.0V

THROTTLE SERVO ARM INSTALLATION

- Install adjustable servo connector in the servo arm as same as picture below:

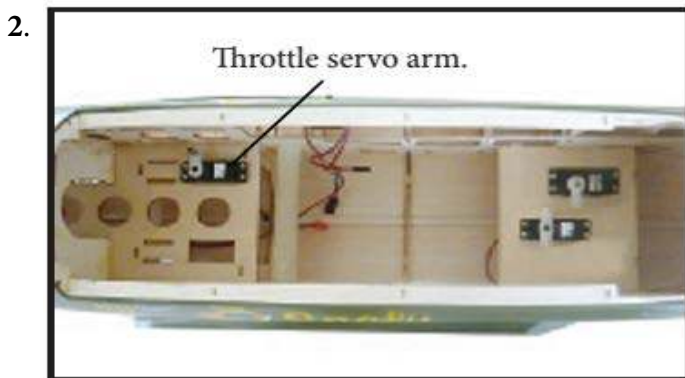
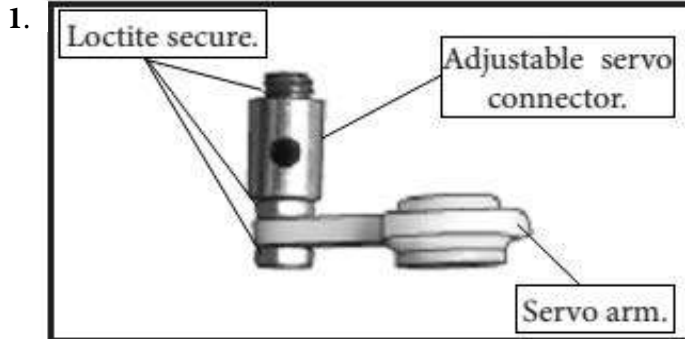

INSTALLING THE STOPPER ASSEMBLY

- Using a modeling knife, carefully cut off the rear portion of one of the 3 nylon tubes leaving 1/2" protruding from the rear of the stopper. This will be the fuel pick up tube.

- Using a modeling knife, cut one length of silicon fuel line. Connect one end of the line to the weighted fuel pick up and the other end to the nylon pick up tube.

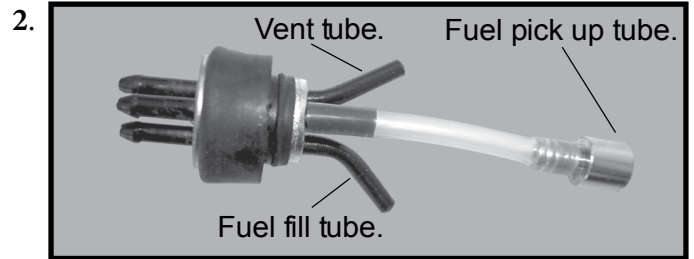
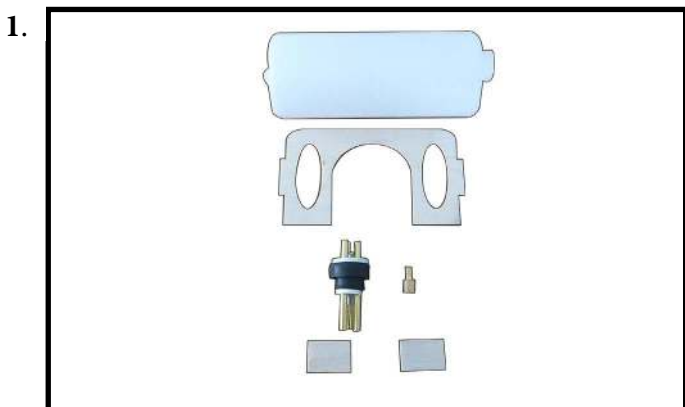

- Carefully bend the second nylon tube up at a 45° angle. This tube is the vent tube.

- Test fit the stopper assembly into the tank. It may be necessary to remove some of the flashing around the tank opening using a modeling knife. If flashing is present, make sure none falls into the tank.

- With the stopper assembly in place, the weighted pick-up should rest away from the rear of the tank and move freely inside the tank. The top of the vent tube should rest just below the top of the tank. It should not touch the top of the tank.

- When satisfied with the alignment of the stopper assembly tighten the 3 x 20mm machine screw until the rubber stopper expands and seals the tank opening. Do not overtighten the assembly as this could cause the tank to split.

FUEL TANK INSTALLATION



! You should mark which tube is the vent and which is the fuel pickup when you attach fuel tubing to the tubes in the stopper. Once the tank is installed inside the fuselage, it may be difficult to determine which is which.

- Slide the fuel tank into the fuselage. Guide the lines from the tank through the hole in the firewall.

- Use plywood template to hold in place the fuel tank with C/A glue to secure the fuel tank inside the fuselage.

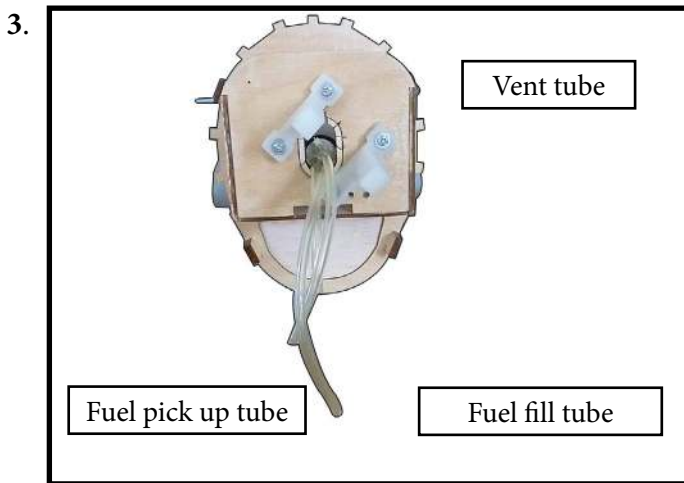

- Connect the lines from the tank to the engine and muffler. The vent line will connect to the muffler and the line from the clunk to the carburetor.

! *Blow through one of the lines to ensure the fuel lines have not become kinked inside the fuel tank compartment. Air should flow through easily.*

MOUNTING THE ENGINE - 2 stroke

- Position the engine with the drive washer (145mm) forward of the firewall as shown.

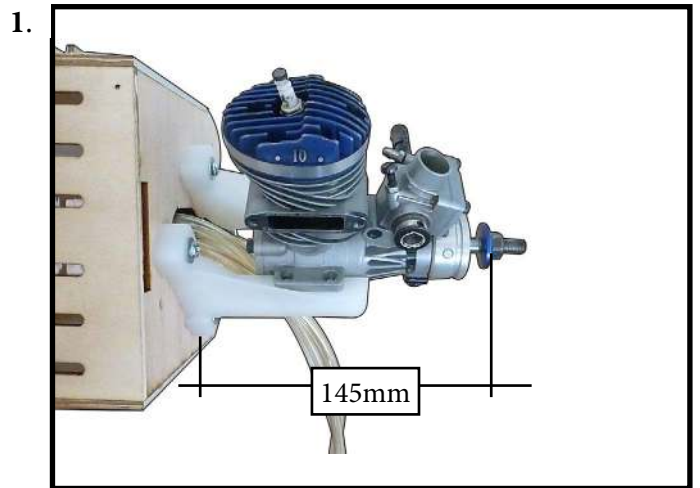

- Use a pin drill and 4mm drill bit to drill a small indentation in the mount for the engine mounting screw.

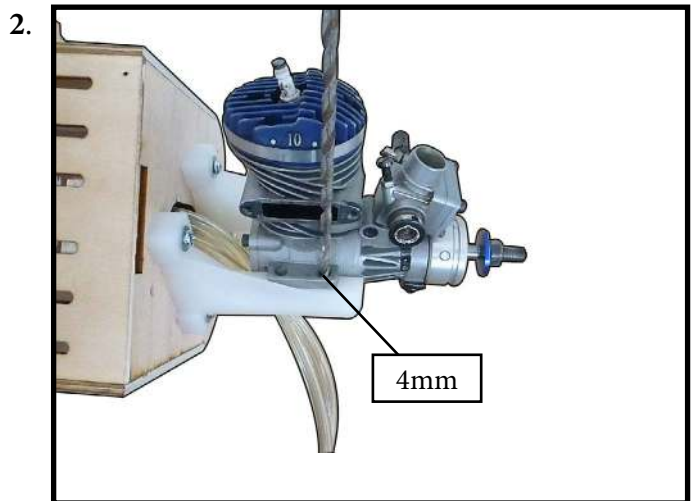

- Use a drill to drill the four holes in the engine mount rails.

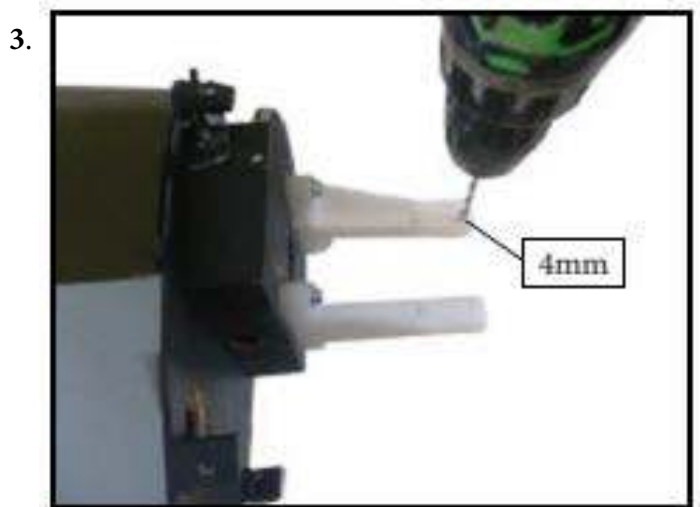

- On the fire wall has the location for the throttle pushrod tube (pre-drill).

- Slide the pushrod tube in the fire wall and guide it through the fuel tank mount. Use medium C/A to glue the tube to the fire wall and the fuel tank mount.

- Connect the Z-bend in the 450mm throttle pushrod to the outer hole of the carburetor arm.

- Slide the throttle pushrod wire into the tube. Position the engine between the mounts. Use four M4x30mm machine screws to secure the engine to the mount as shown.

4.

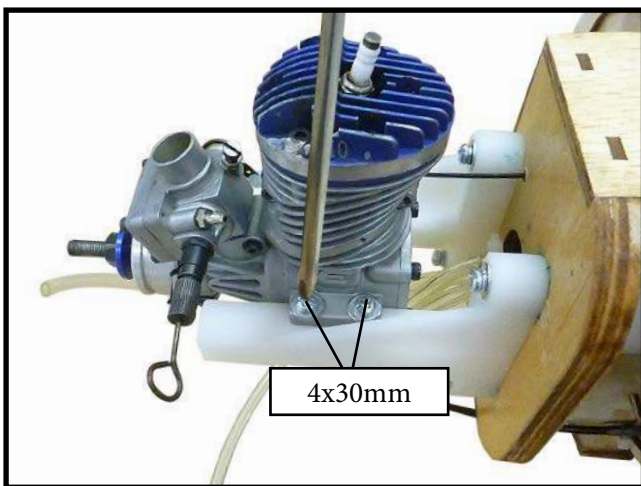

- Reinstall the servo horn by sliding the connector over the pushrod wire. Center the throttle stick and trim and install the servo horn perpendicular to the servo center line.

5.



- Move the throttle stick to the closed position and move the carburetor to closed. Use a 2.5mm hex wrench to tighten the screw that secures the throttle pushrod wire. Make sure to use threadlock on the screw so it does not vibrate loose.

6.



COWLING

- Please see below pictures.

1.



2.



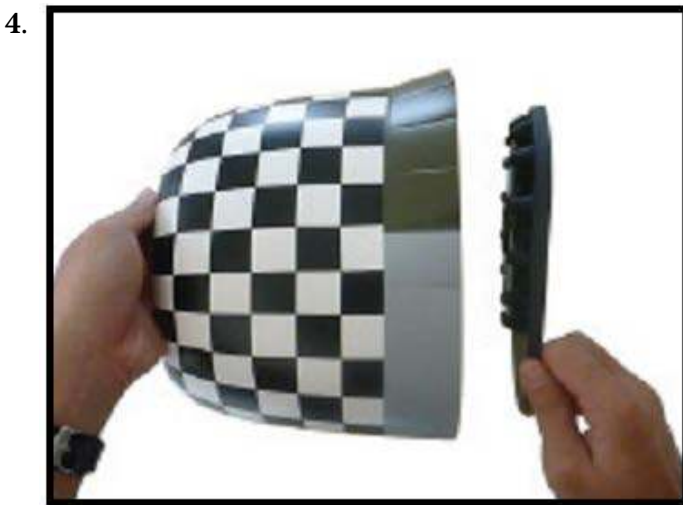
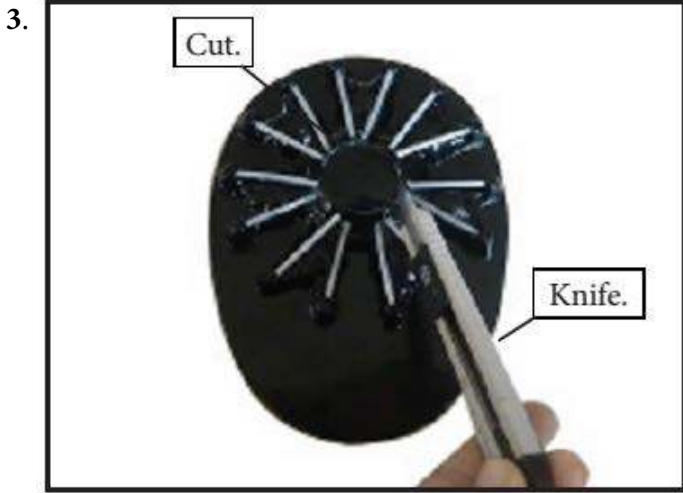

- Slide the fiberglass cowl over the engine and line up the back edge of the cowl with the marks you made on the fuselage then trim and cut as shown.

- Because of the size of the cowl, it may be necessary to use a needle valve extension for the high speed needle valve. Make this out of sufficient length 1.5mm wire and install it into the end of the needle valve. Secure the wire in place by tightening the set screw in the side of the needle valve.

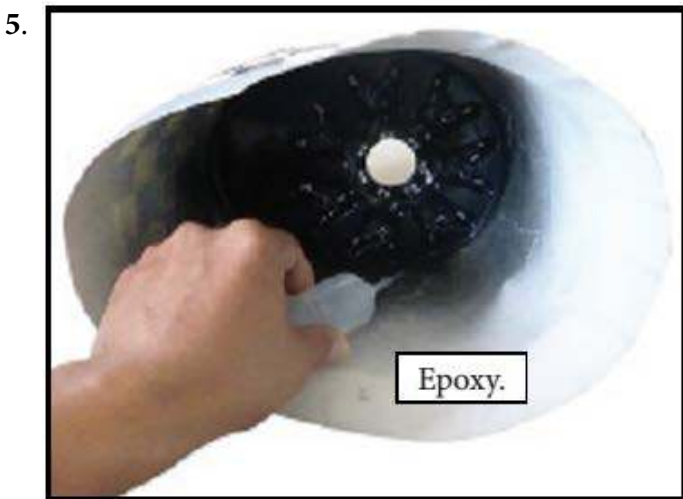

- While keeping the back edge of the cowl flush with the marks, align the front of the cowl with the crankshaft of the engine. The front of the cowl should be positioned so the crankshaft is in nearly the middle of the cowl opening. Hold the cowl firmly in place using pieces of masking tape.

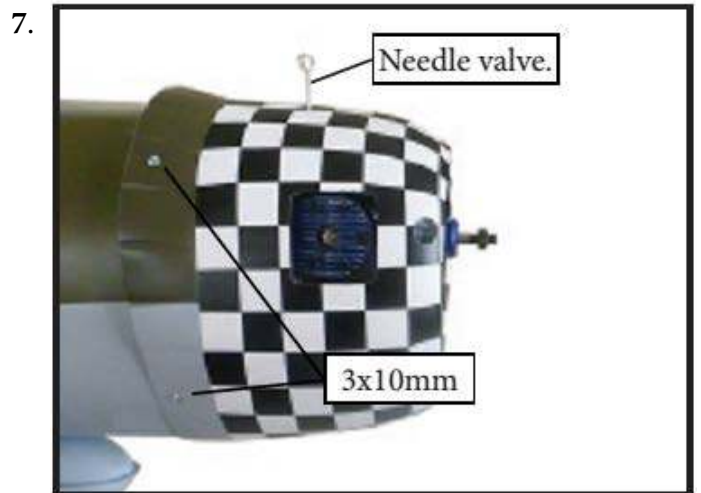

- Install the mufer and mufer extension onto the engine and make the cutout in the cowl for mufer clearance. Connect the fuel and pressure lines to the carburetor, mufer and fuel filler valve. Secure the cowl to fuse lage using the M3x10mm screws.

BUILD THE CANOPY

1.



- Install the ribs for canopy include H1, H2, H3, H4, H5, H6, H7, H8, H9 by CA glue.

2.

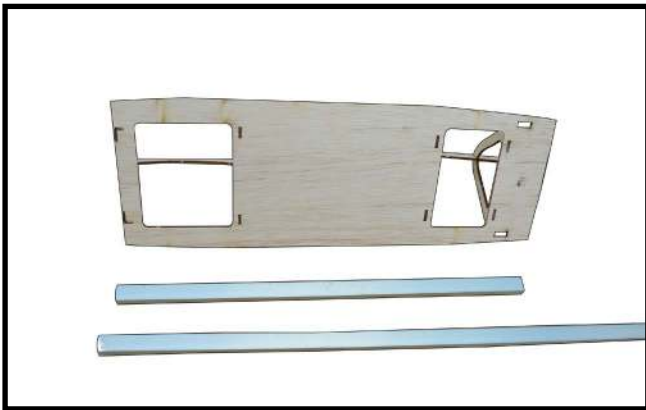

- Getting prepare aluminium square tool (2pcs) and the rib of canopy.

3.



- Paste prepare aluminium square tool on canopy at the bottom by sticky tape.

4.

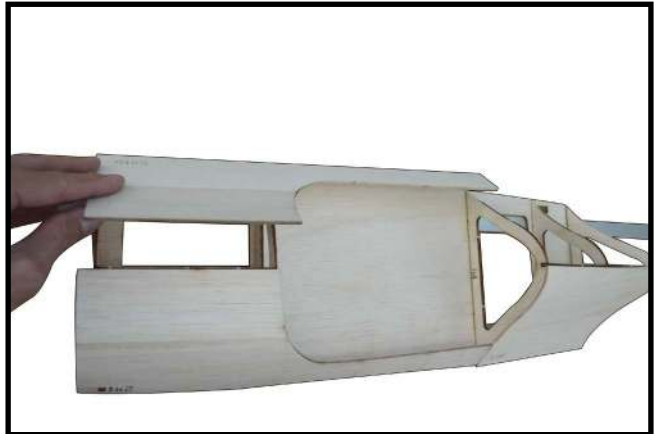

- Cover balsa sheet SH10 on the rib of canopy at the both side.

5.

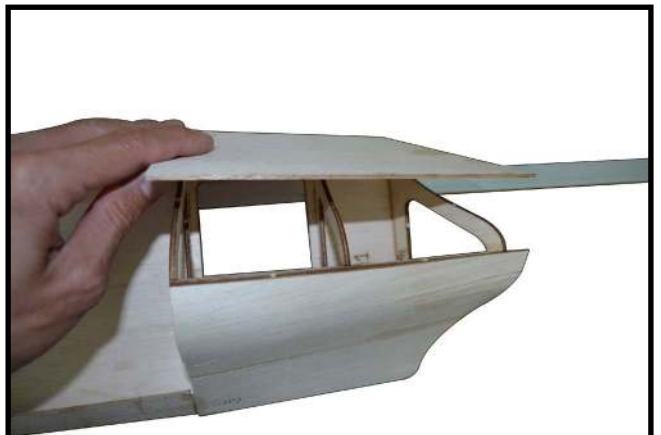

- Cover balsa sheet SH9 on the rib of canopy at the both side.

6.



- Building the canopy was finished.

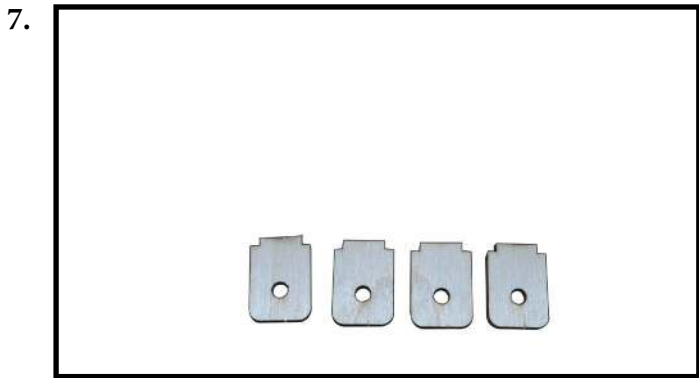

- Getting prepare 2 set of latch at behind include H10' (4pcs).

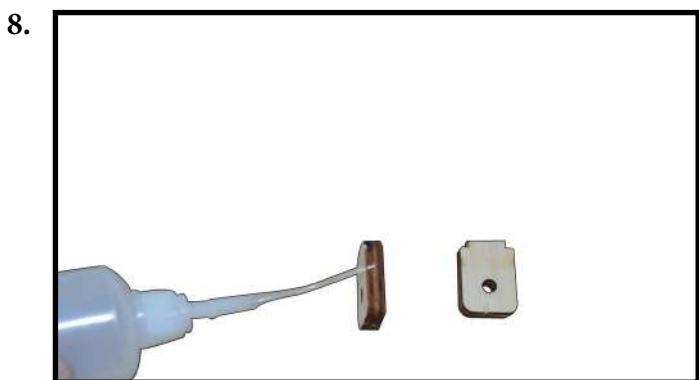

- Paste 2 pieces together make for each the latch by CA glue.

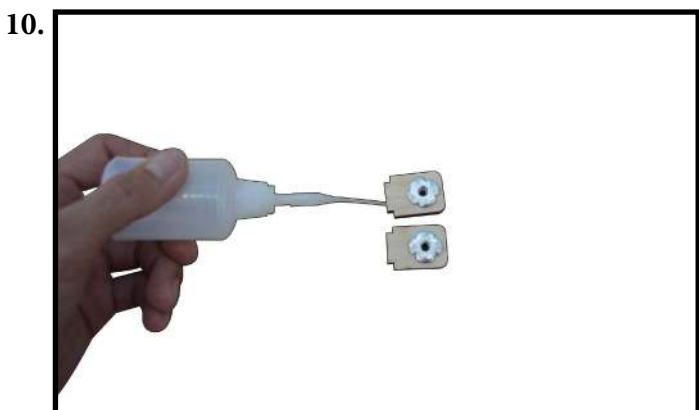
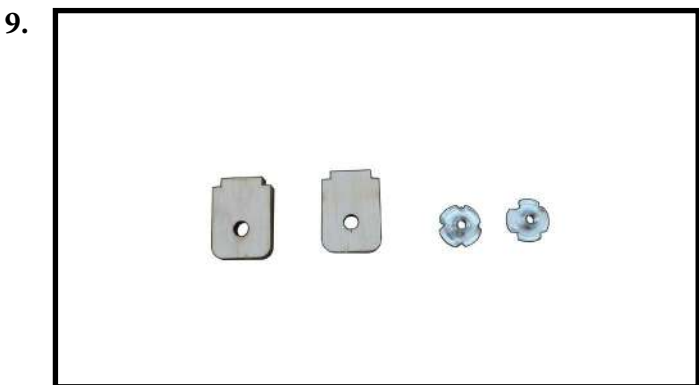

- Attach M4 blind nut to the latch and then fill CA glue around.



- Attach the latch to canopy at behind by CA glue.

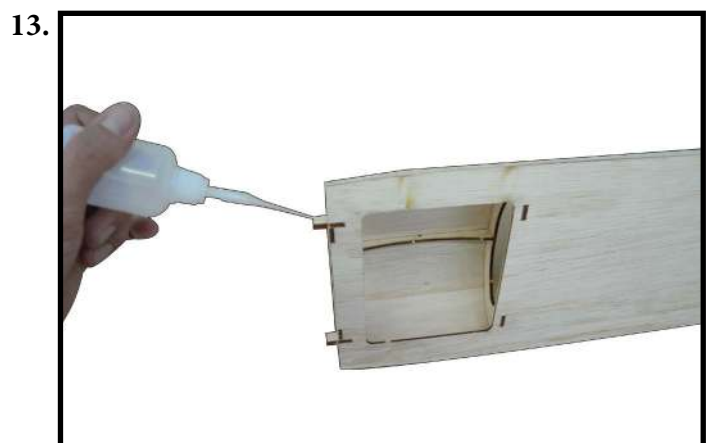
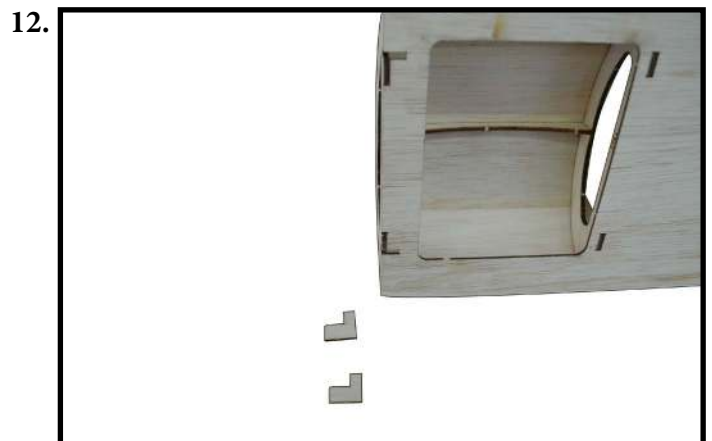

- Attach the latch to canopy at before by CA glue.



- Install canopy to fuselage and use the sandpaper bar so that sanding for canopy and fuselage until look seamless.

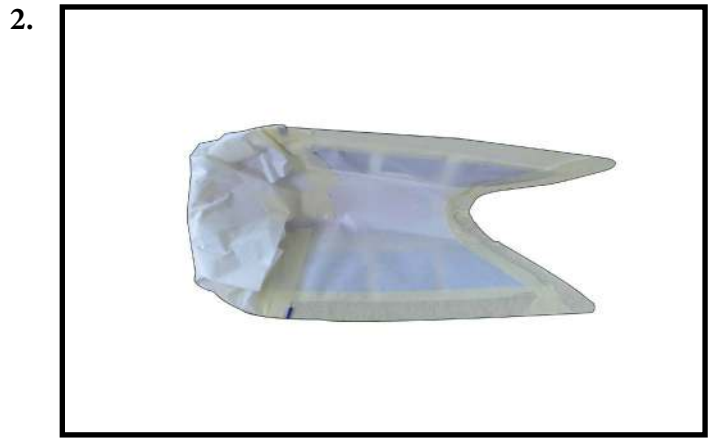

- Cover the rest of the clear area with masking tape so that mask off protect it from over spray (photo 15.16).

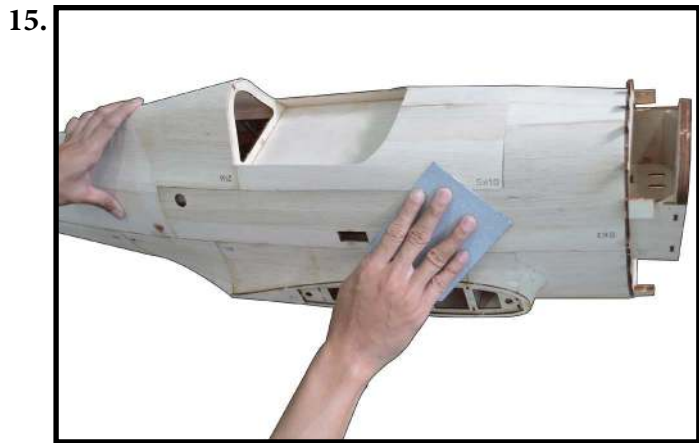

- Use sandpaper to sanding all around the fuselage.

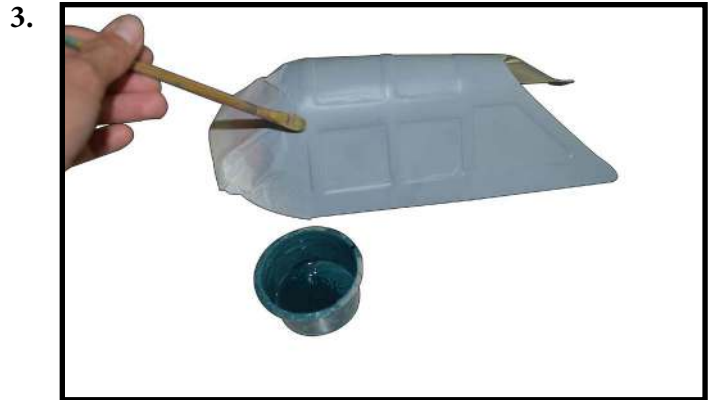

- Paint the canopy frame.

PAINT THE CANOPY FRAME

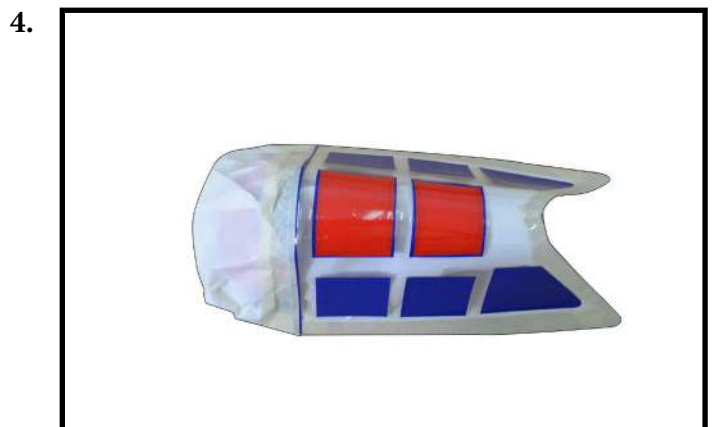

- Remove the paper.

INSTALLATION PILOT AND CANOPY

- Locate items necessary to install pilot, seats.

1.



- A scale pilot is included with this ARF. The Pilot included fitting well to the coc pit. (or you can order others scale pilot fiures made by SG Models. They are available at SG Models distributors.)

- If you are going to install a pilot fiure, please use a sanding bar to sand the base of the fiure so that it is flat.

- Position the pilot fiure on the canopy flor as show. Locate the oval shaped on the canopy flor and remove the covering. Use epoxy to glue this into the base of the pilot fiure and glue the cockpit panel in place with C/A glue, please see pictures as shown.

2.

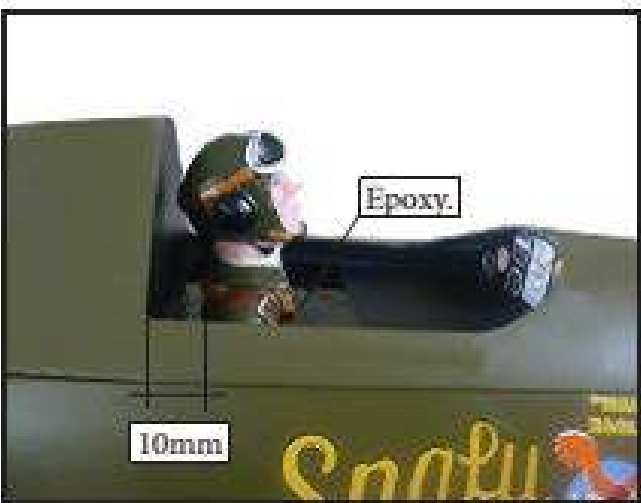

3.

- Position the canopy onto the fuselage. Trace around the canopy and onto the fuselage using a felt-tipped pen.



BUILD SET OF THE WING

1.

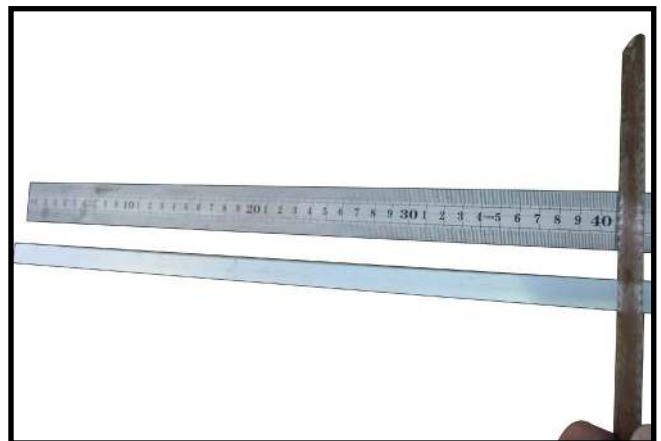

- Getting prepare the Aluminium Square Fixed Tool with 41cm length.

2.



- Getting prepare the perpendicular frame include 2 pcs paste on together.

3.

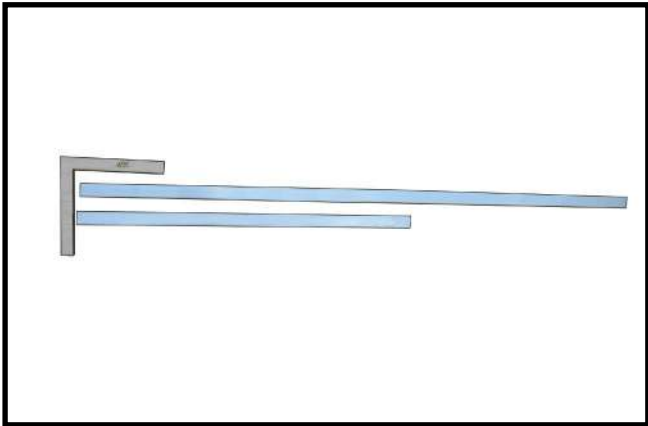

- The Aluminium Square Fixed Tool be separated 2 parts.

4.

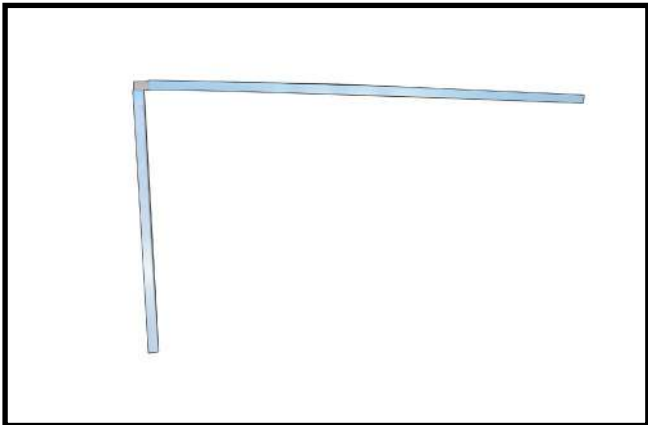

- Weld 2 parts the Aluminium Square Fixed Tool as perpendicular aluminium frame.

5.



- Getting prepare trailing edge include W28 and W29.

6.

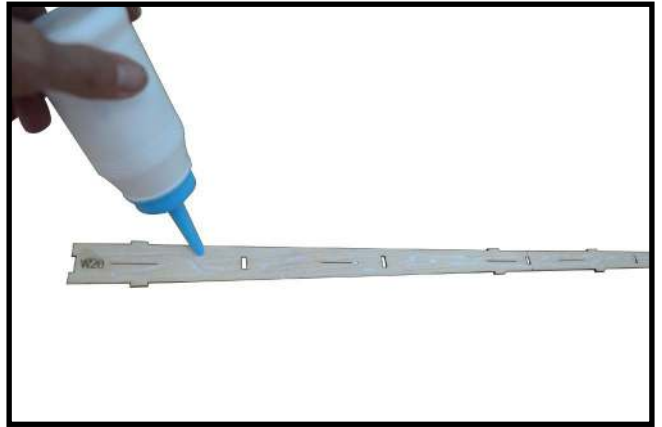

- Paste W28 on W29 by White Glue.

7.

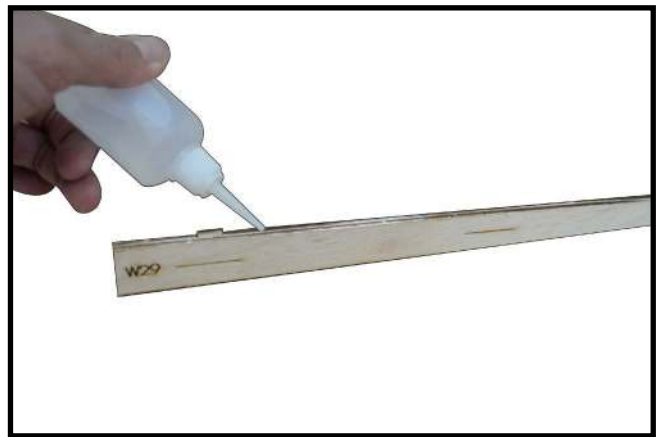

- Apply thin CA Glue around block include 2 layers of trailing edge.

8.

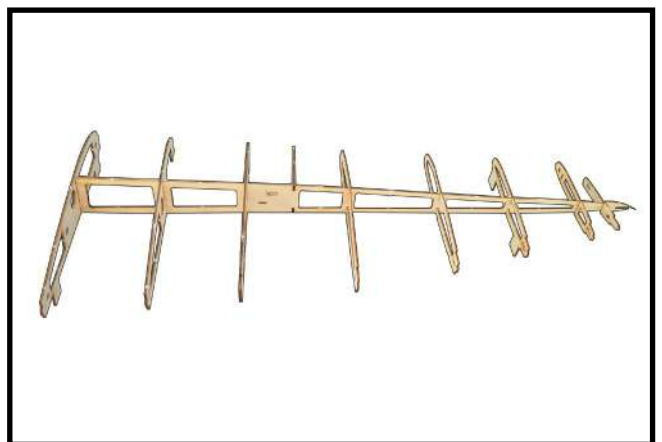

- Buid the ribs for wing.

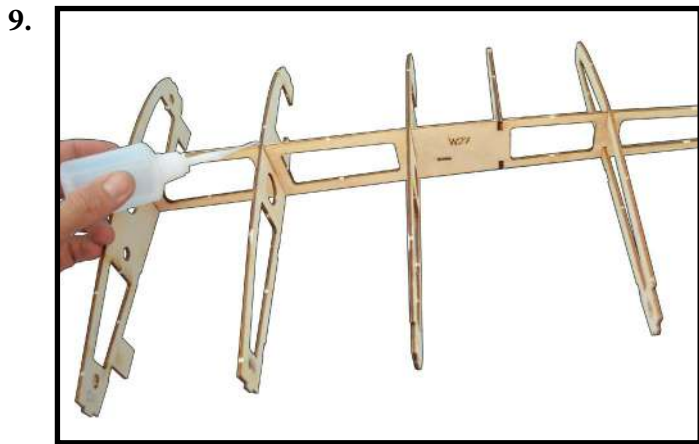

- Apply CA Glue to keep fixed the airfoil.

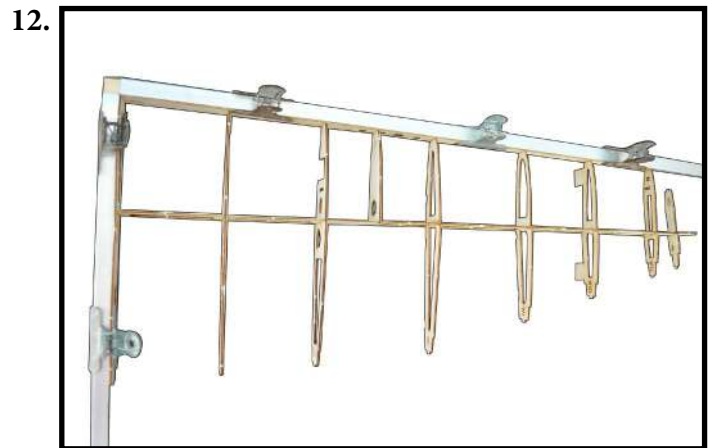

- Use the clamp to hold on perpendicular aluminum frame and the ribs of wing together.

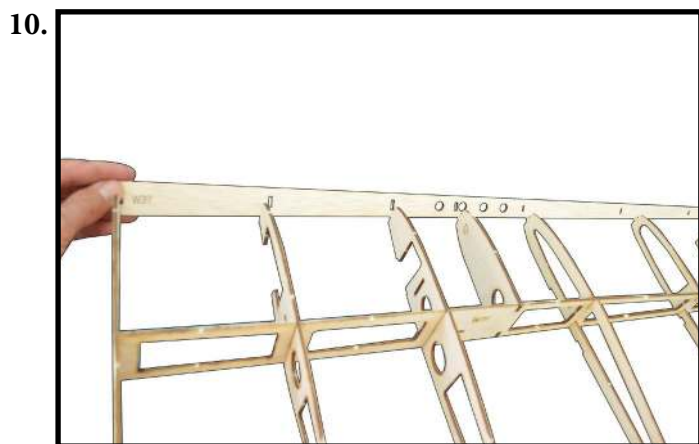

- Install leading edge to the ribs of wing.

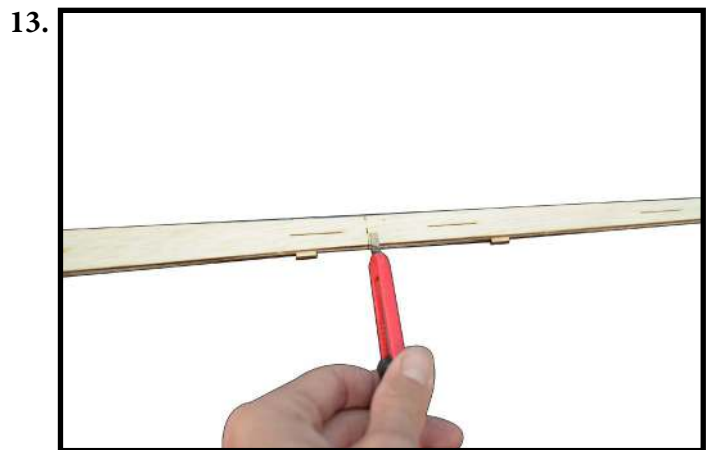

- Use cutter knife to cut trailing edge at mark but cutting do not cut off.

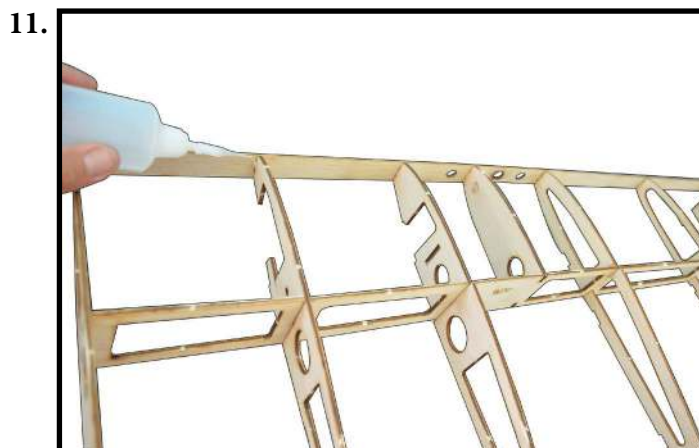

- Apply CA Glue to keep fixed leading edge.

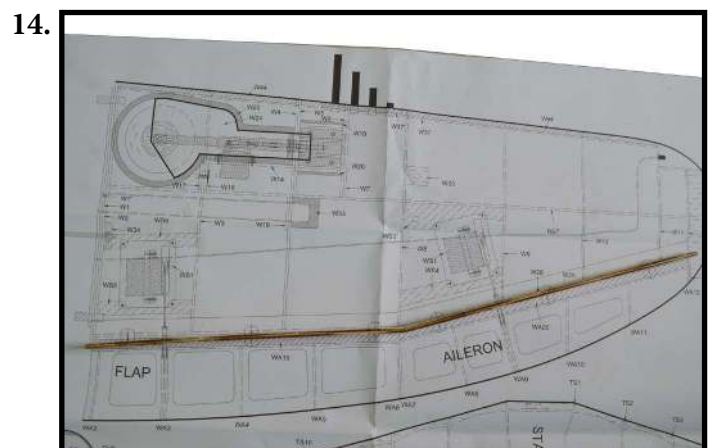

- Bend to create for the trailing edge as photo.

Please kindly see the view of wing in the drawing sheet. 18.

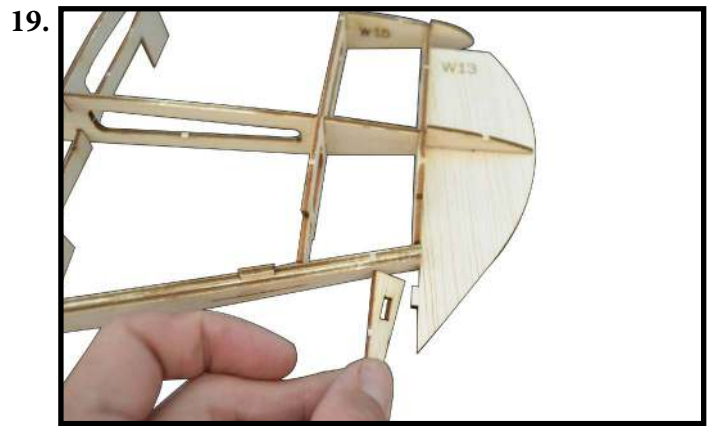
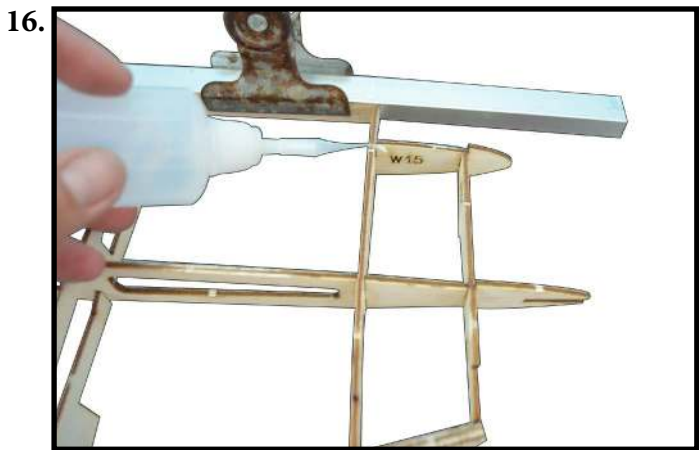
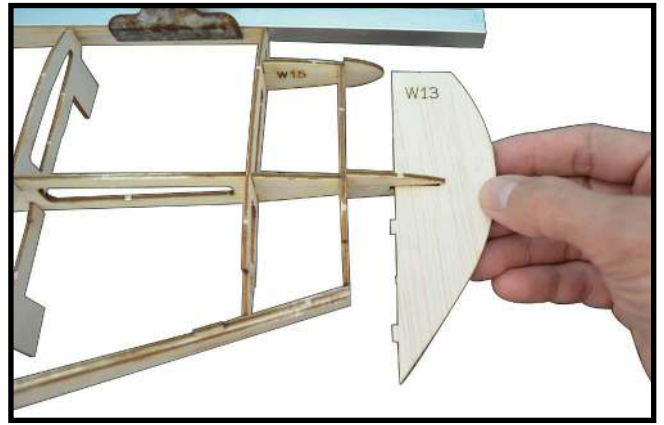
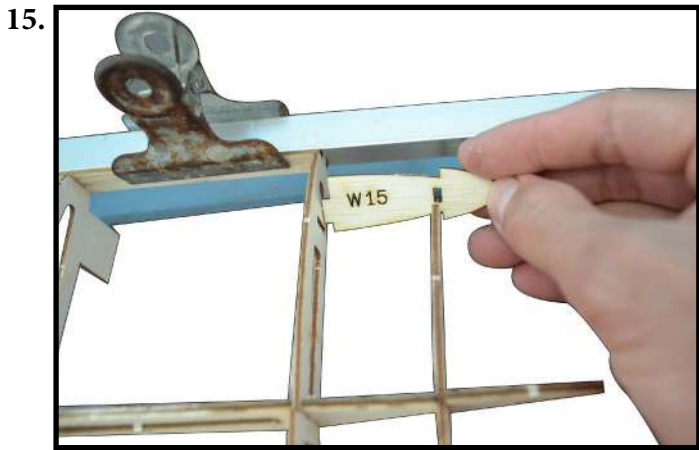

- Install F15 to wing and apply CA Glue to keep fixed as photo.

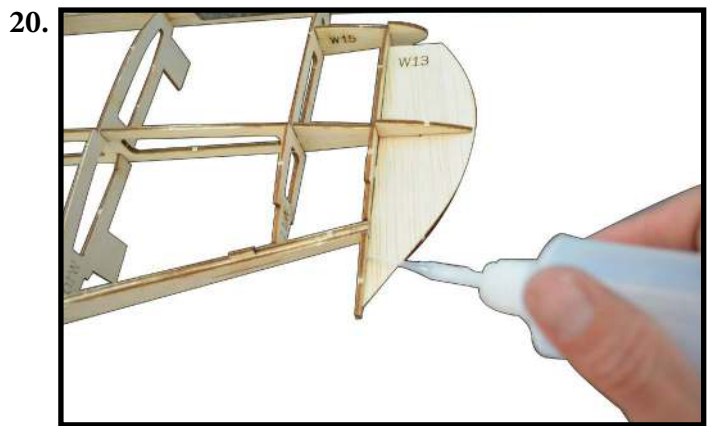

- Install W13 and W32 to wing and apply CA Glue to keep fixed as photo.

- Use sandpaper bar to sanding at the end airfoil of wing as photo.

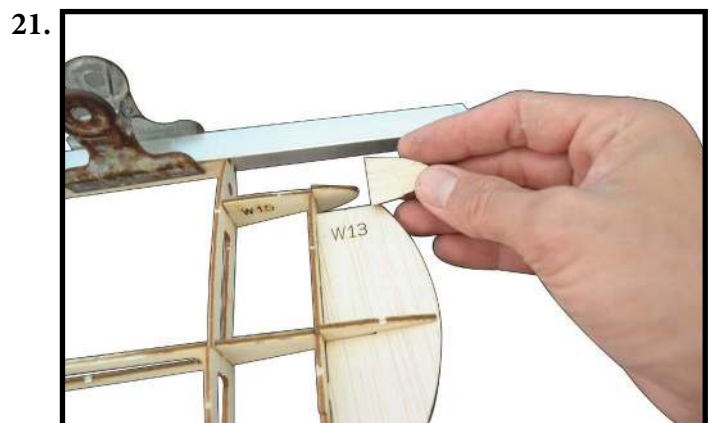

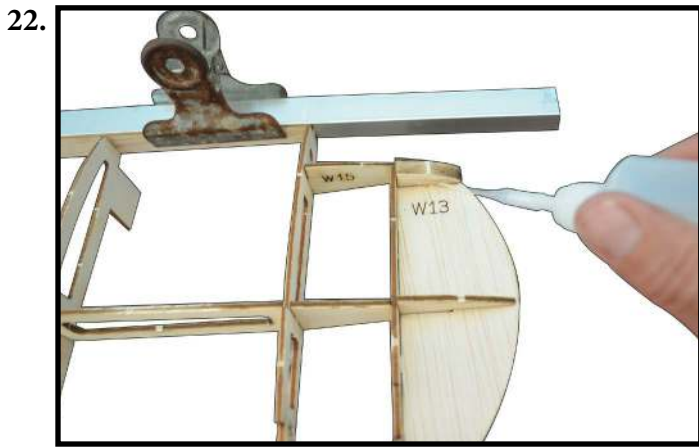

- Install W15 (6mm balsa wood) to wing and apply CA Glue to keep fixed as photo.

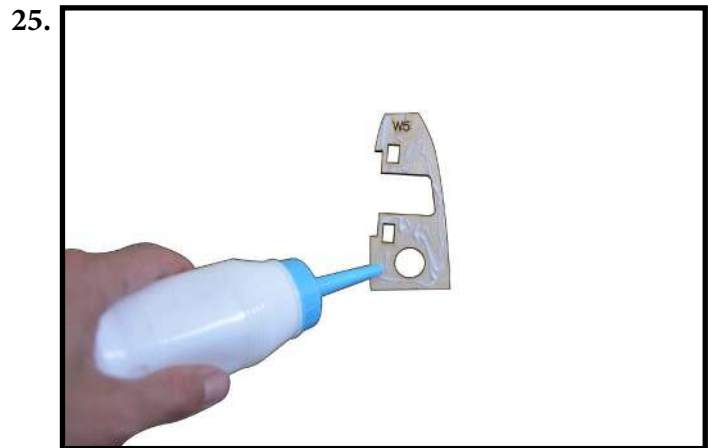

26.

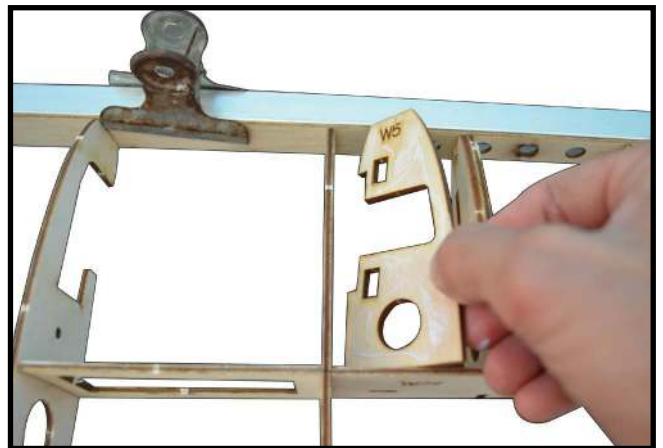

- Install W5 to wing by White Glue to keep fixed as photo.

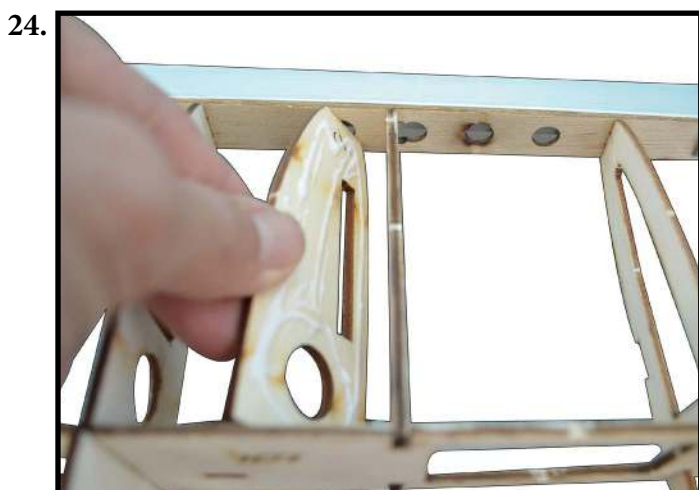
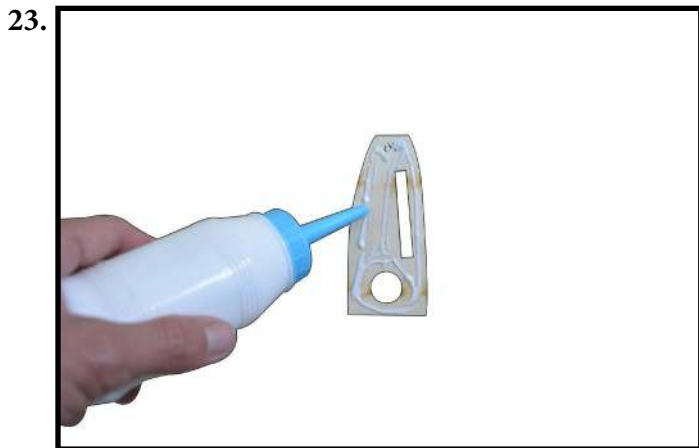

- Install W6 to wing by White Glue to keep fixed as photo.

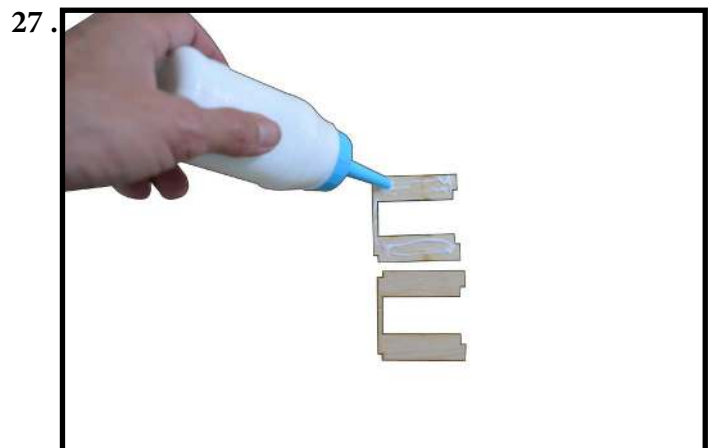

- Paste two pieces retract gear mount W21 together by White Glue.

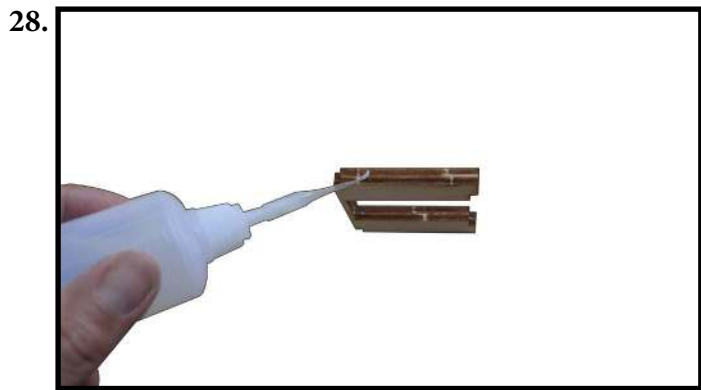

- Apply thin CA Glue to around block include 2 layers W21.

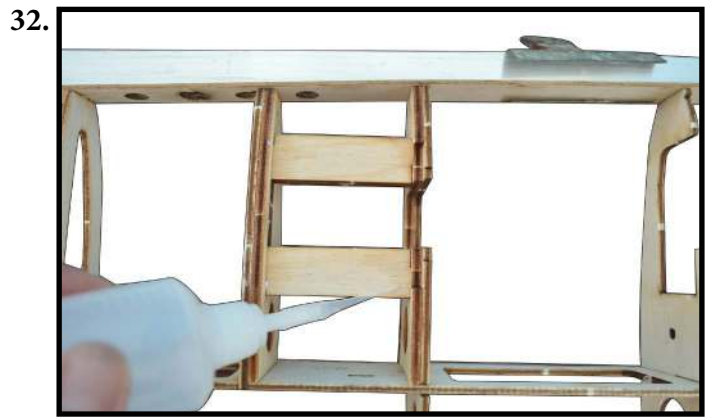

- Install retract gear mount W21 to wing by White Glue and then fill CA Glue to keep fixed.

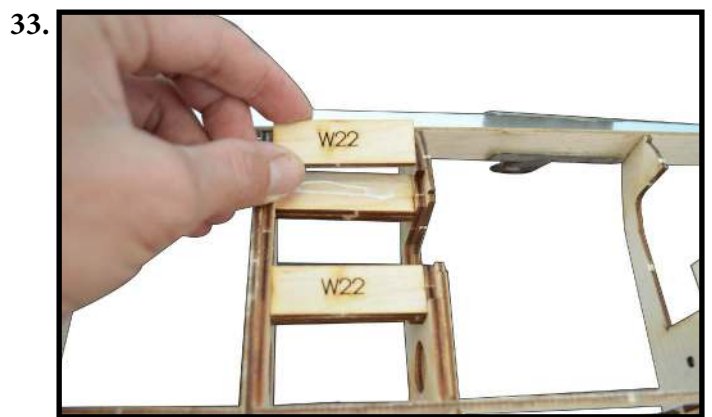

- Paste W22 on W21 by White Glue as photo.

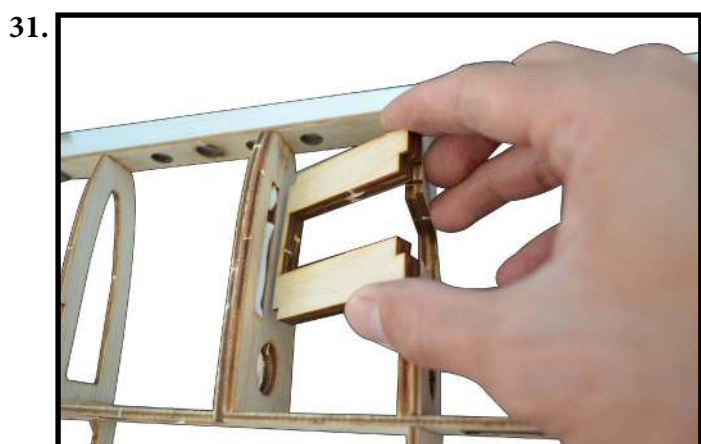
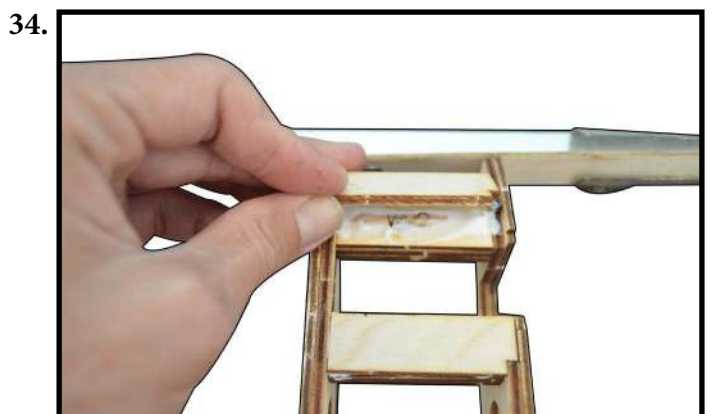
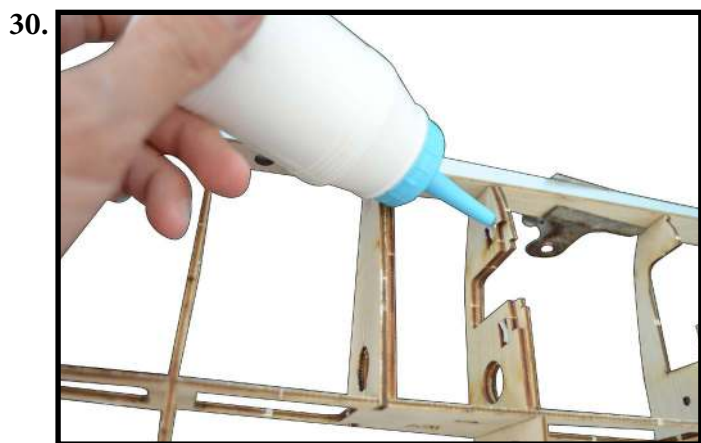

- Paste W23 on block include W21, W22 by White Glue and then fill CA Glue to mount to keep fixed.

- Getting prepare set of nut for nylon bolt include W34 (2pcs) and a nylon nut as photo.

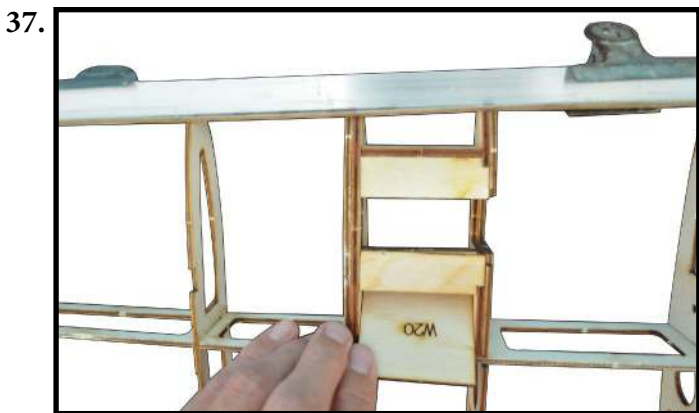
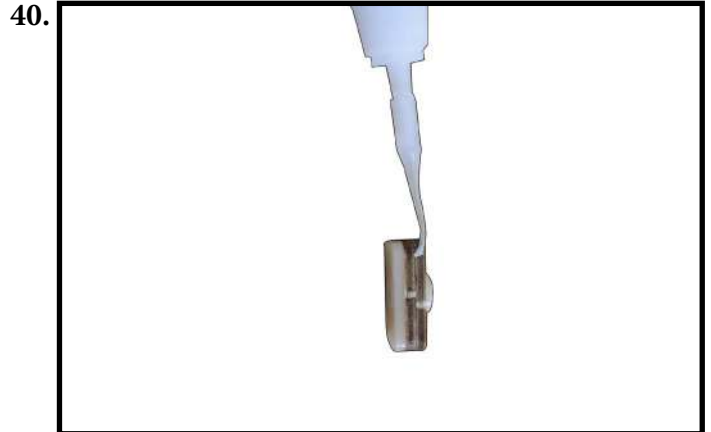
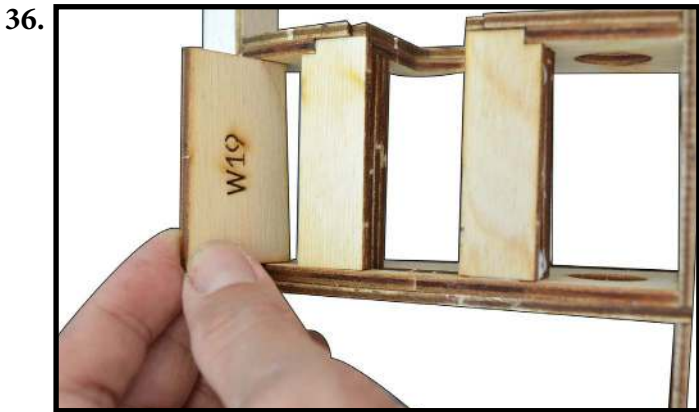

- Paste two pieces W34 and a nylon nut together by CA glue.

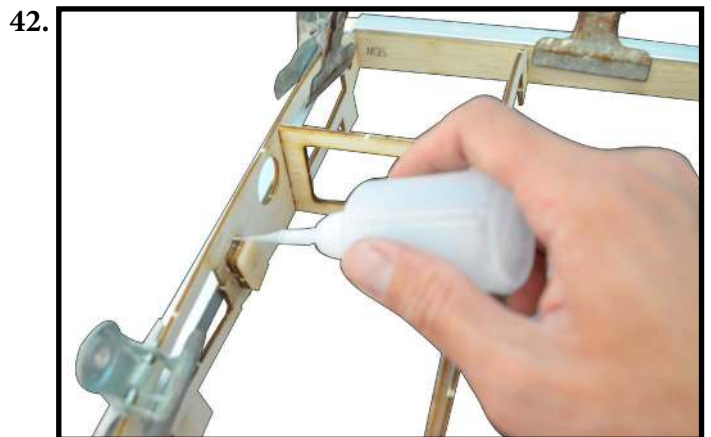

- Install W19 and W20 to wing by White Glue and then apply CA glue to keep fixed as photo.

- Install block of nut to wing root by by CA glue as photo.





- Apply CA glue to keep fixed W18.

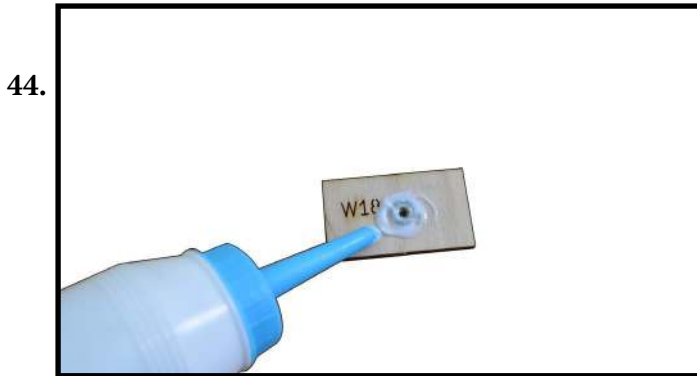

- Getting prepare W18 and M3 blind nut and attaching M3 blind nut to W18 by White glue.

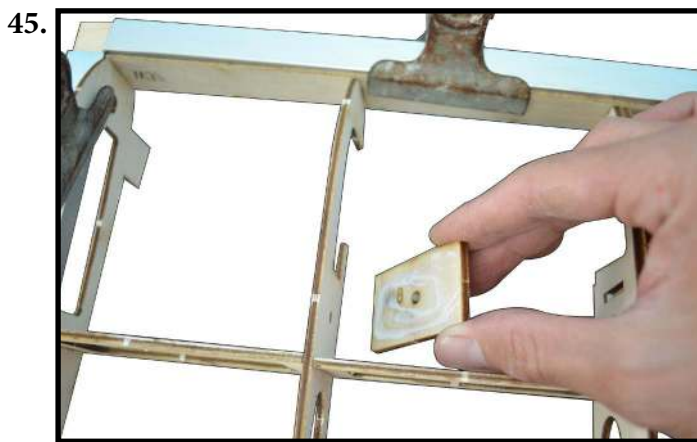

- Install W18 with blind nut available to W2 by White glue.

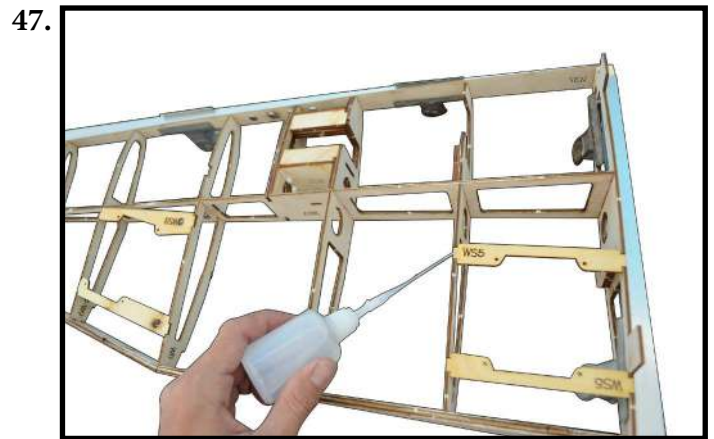
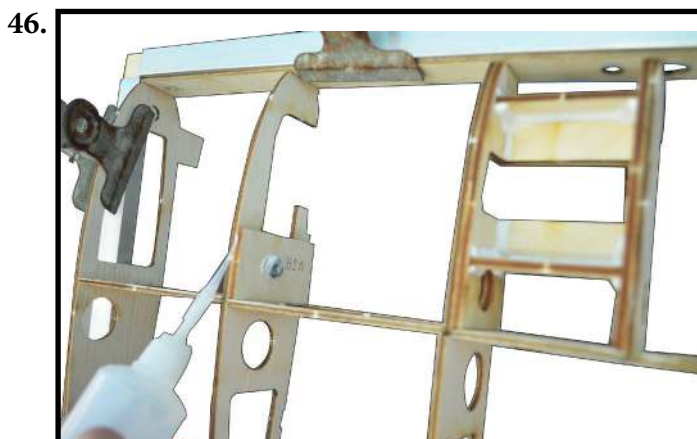

- Install servo mount WS3, WS4, WS5 to wing by CA glue.

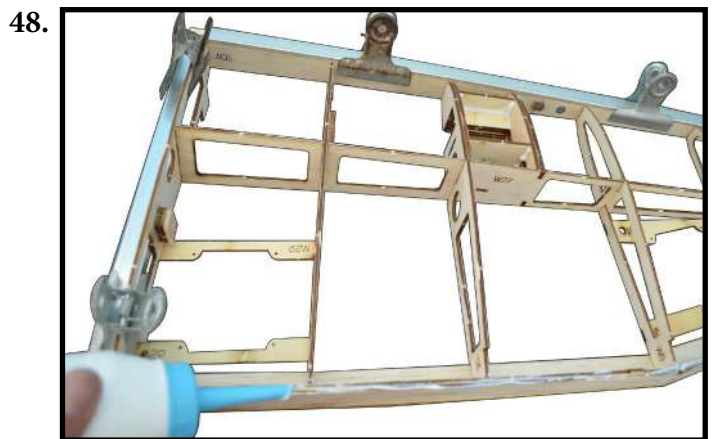

- Apply White glue on trailing edge as photo.



- Cover the balsa sheet W41, attach the balsa sheet to tabs of trailing edge.



- The side of wing with servo mount flip up as photo.



- Sheeting was finished.

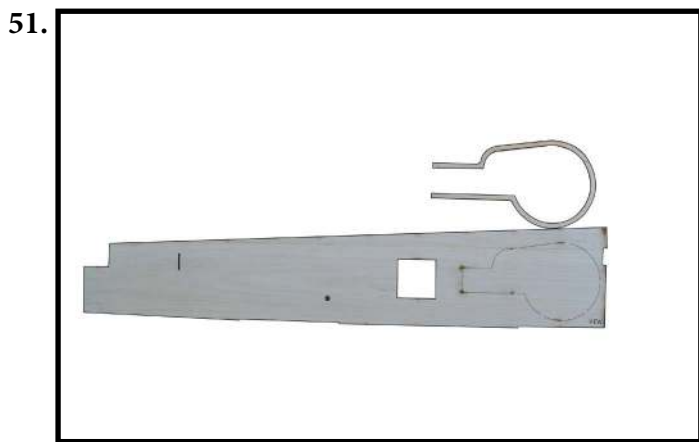

- Apply balsa frame W25 to balsa sheet W39 at mark area for wheel's well.

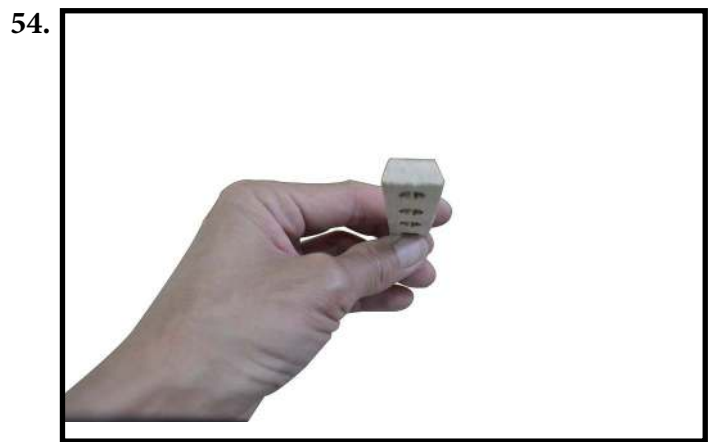

-Use sandpaper bar to sanding 6mm balsa block make shape for balsa block as photo.



- Cover the balsa sheet W39 with balsa frame W25 available to wing .



- Attach 6mm balsa block to leading edge at mount of gun as photo.

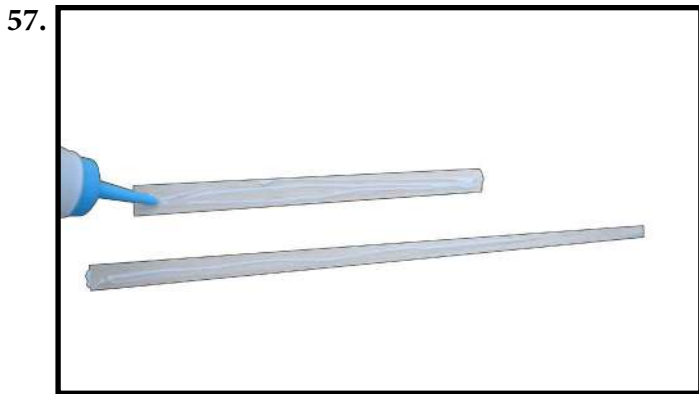
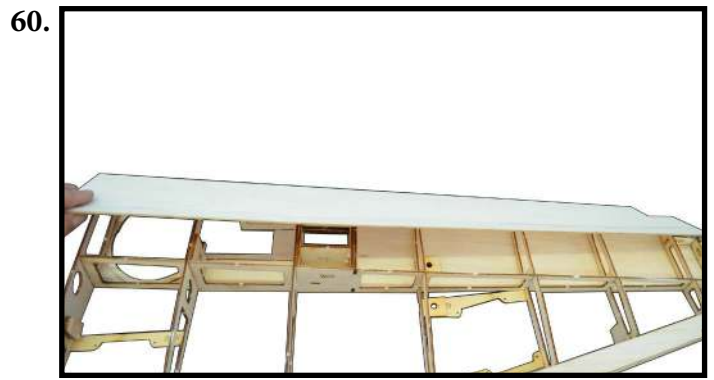
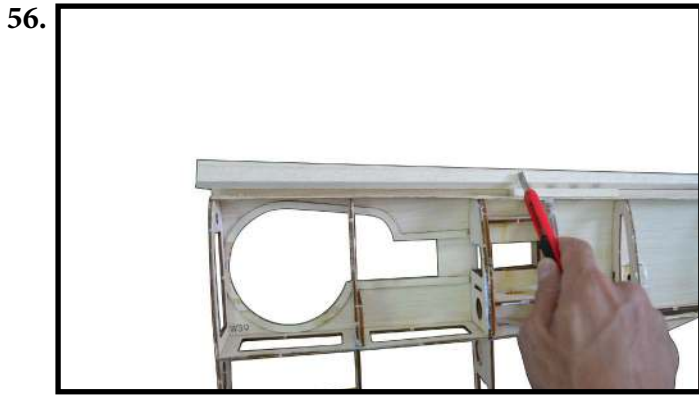

- Measure and split to two fragment of 6mm balsa block for leading edge.



- Hold the sheet down with weights while the glue dries.

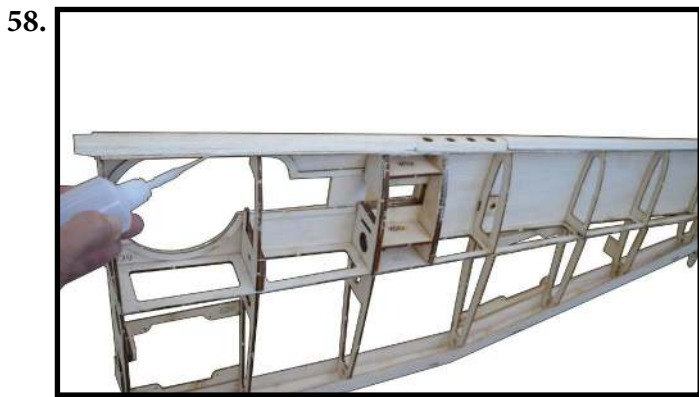

- Attach two fragment of 6mm balsa block to leading edge by CA glue.

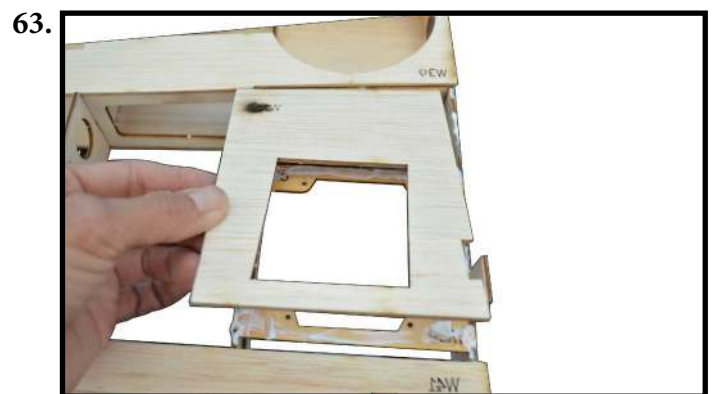
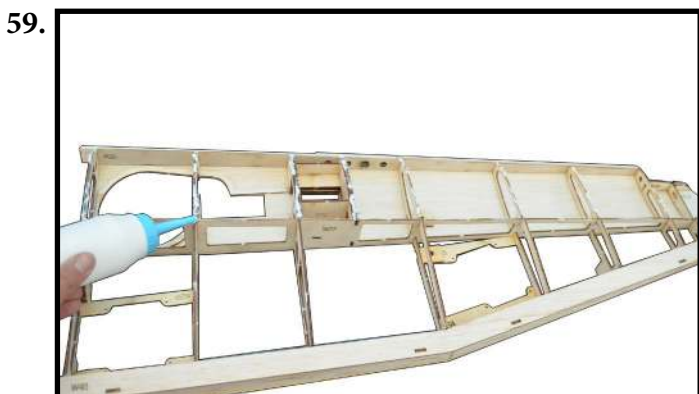
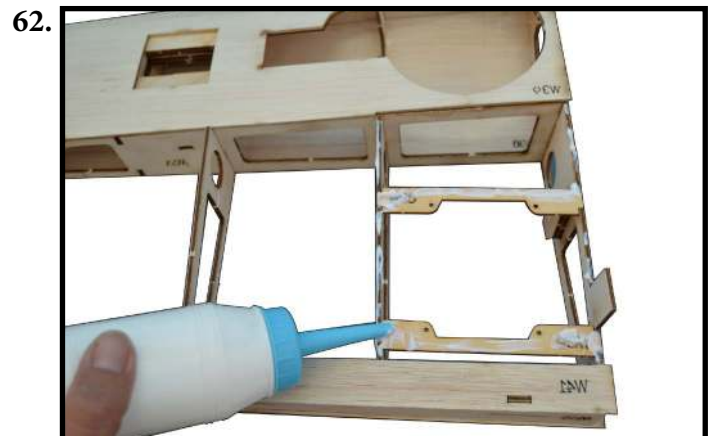

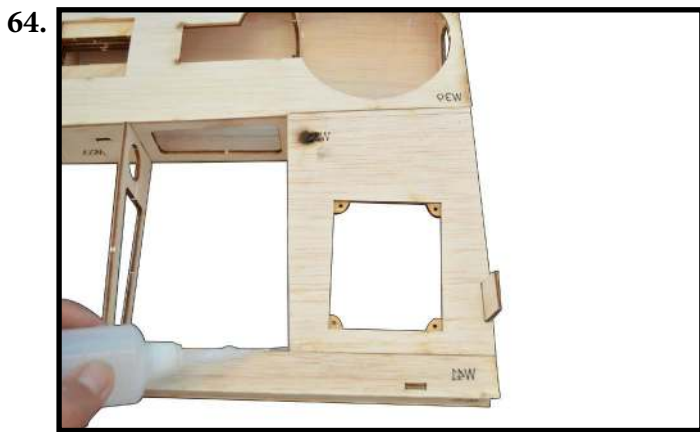

- Install W33 by CA glue.

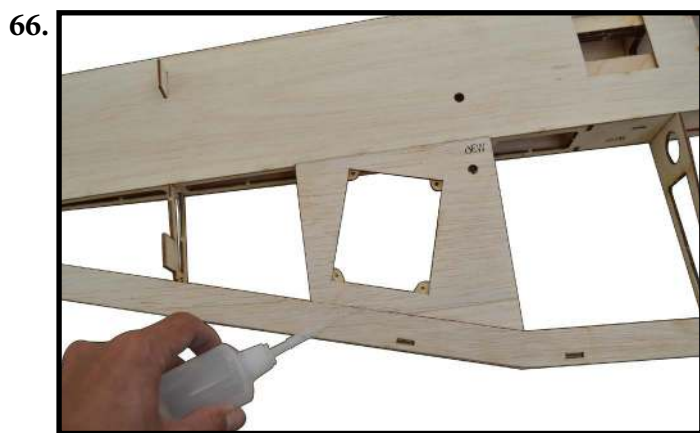
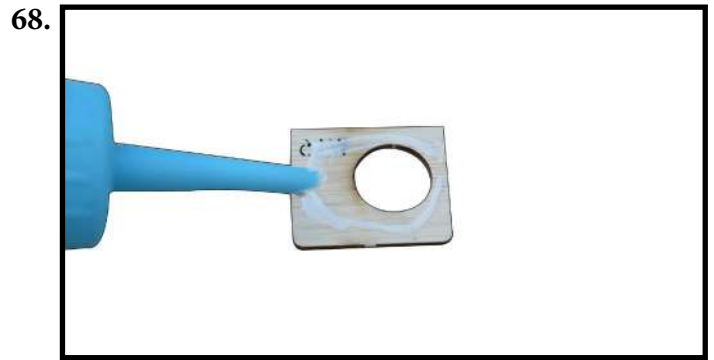

- Paste W16 on W4 by White Glue.



- Cover balsa sheet W35 and W36 at servo area (photo 62 to 66).



- The paper tube through W1, W2, W3, W4 and then apply White glue at intersection of the wing rib and the tube as photo.

72.



- Cut off the paper tube at wing root as photo.

73.

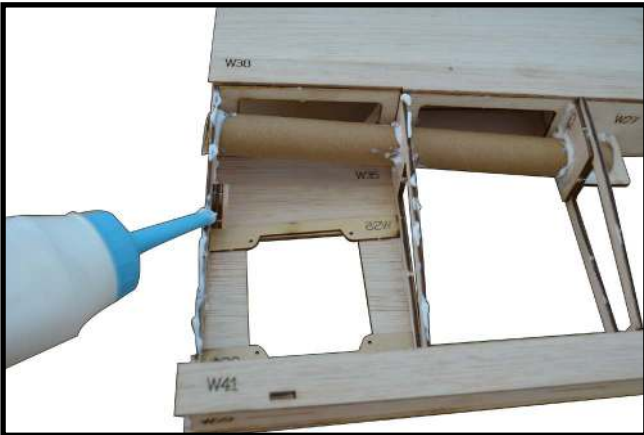

74.



- Cover balsa sheet W40 by white glue.

75.

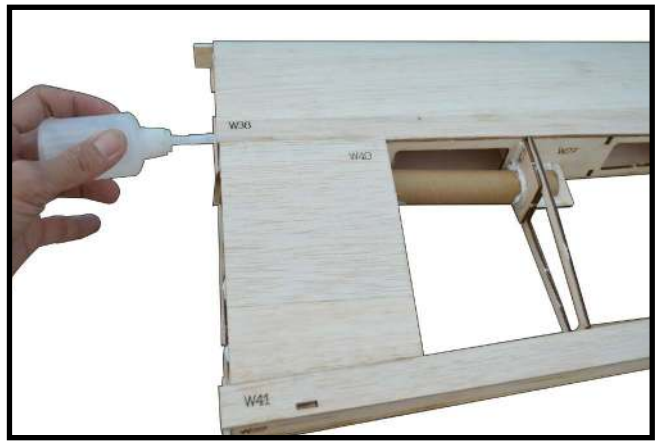

- Apply CA glue to keep fixed W40.

76.



- Use sandpaper bar to sanding at 6mm balsa block W15' as photo.

77.



- Sanding was finished.



- Use sandpaper bar to sanding at trailing edge .



- Paste W1' on W2 by white glue.



- The aluminium tube through the ribs and then fill CA glue to keep fixed.



- Paste W1 on W1' by CA glue to keep fixed.



- Attach the pin (2pcs) $\varnothing = 8\text{mm}$ to wing root as photo.

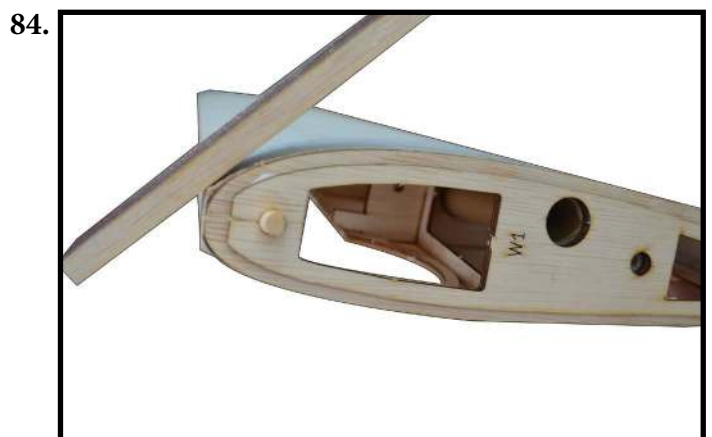

- Use sandpaper bar to sanding at leading edge.

85.

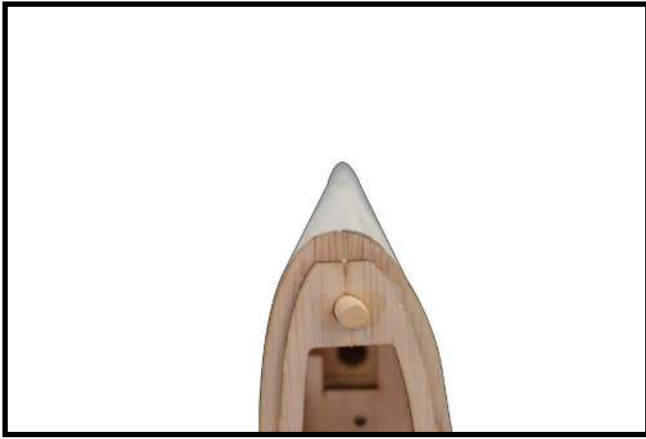

- Sanding leading edge was finished.

86.



- Use sandpaper to sanding around wing.

87.

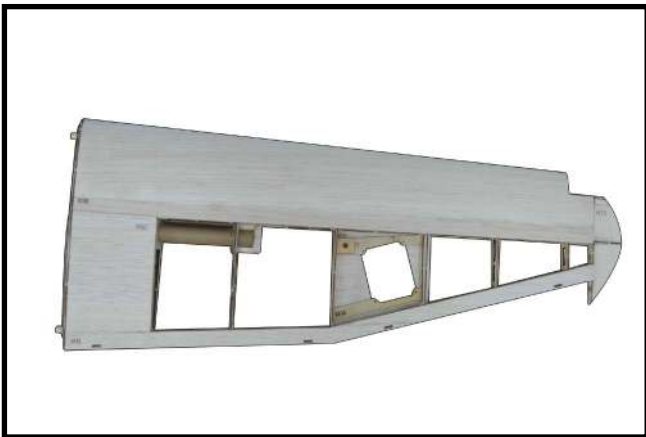

- Building the wing was finished.

BUILD THE FLAP AND AILERON

1.

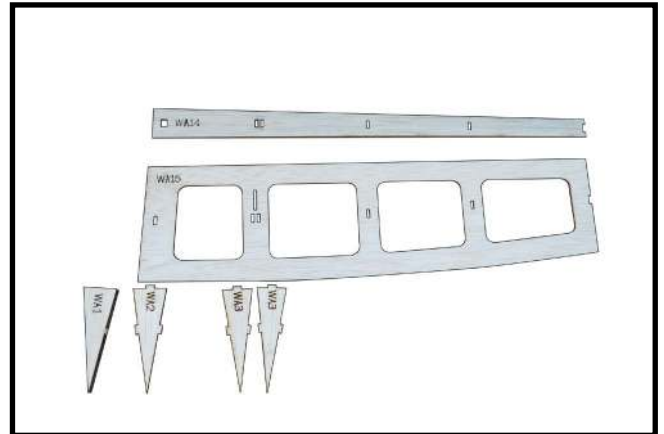

- Getting prepare set of flap as photo.

2.

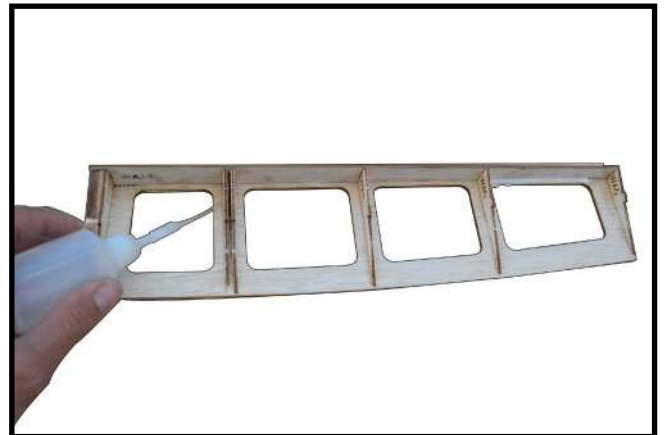

- Install the ribs of flap to balsa sheet WA15 and leading edge of flap WA14 by CA glue.

3.

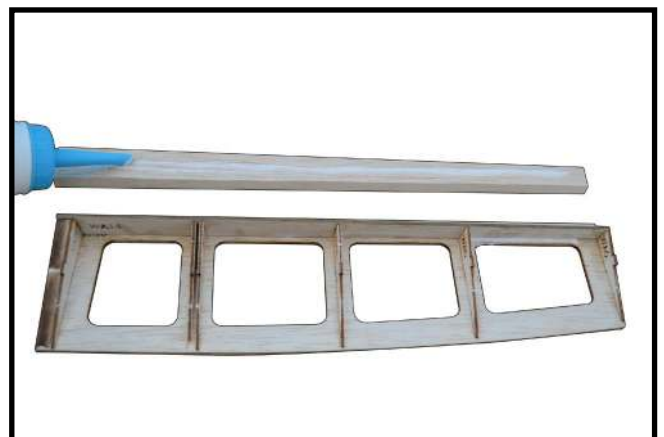

- Paste balsa block WA19 on leading edge of flap by white glue .

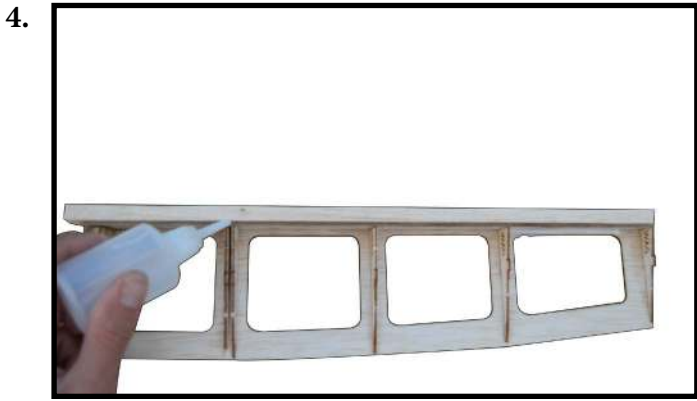

- Apply CA glue at leading edge WA19 with balsa sheet WA15 to keep fixed as photo.

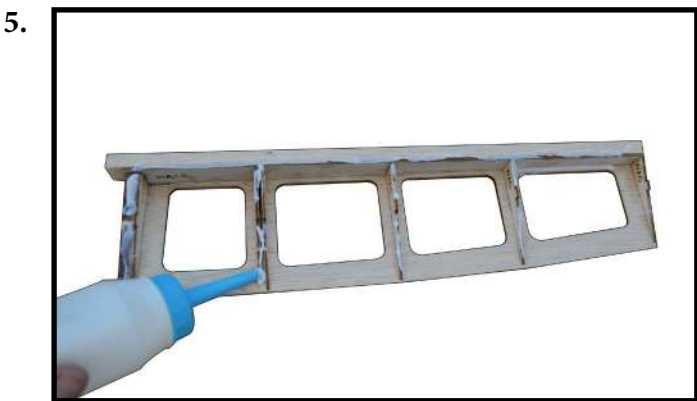

- Apply white glue to the ribs of flap as photo.



- Cover balsa sheet WA16 to the ribs of flap.



- Apply CA glue to keep fixed as photo.

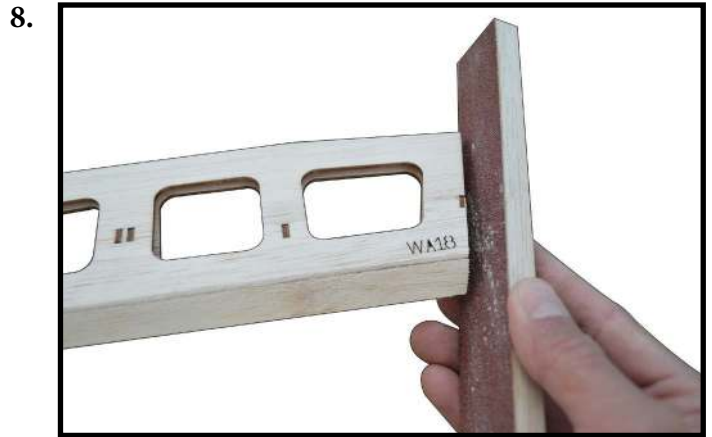

- Use sandpaper bar to sanding at root rib of flap.

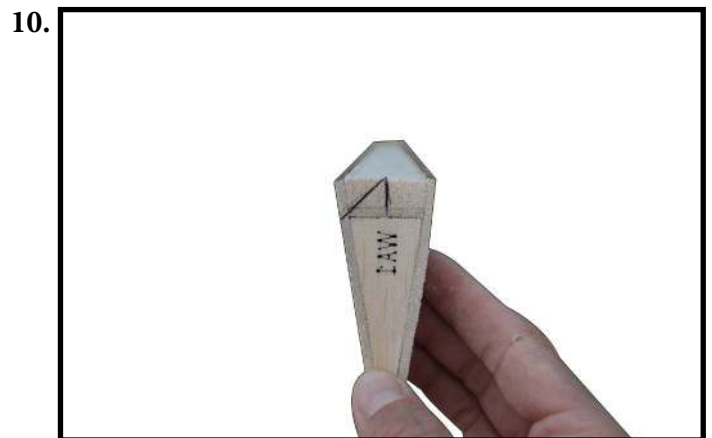
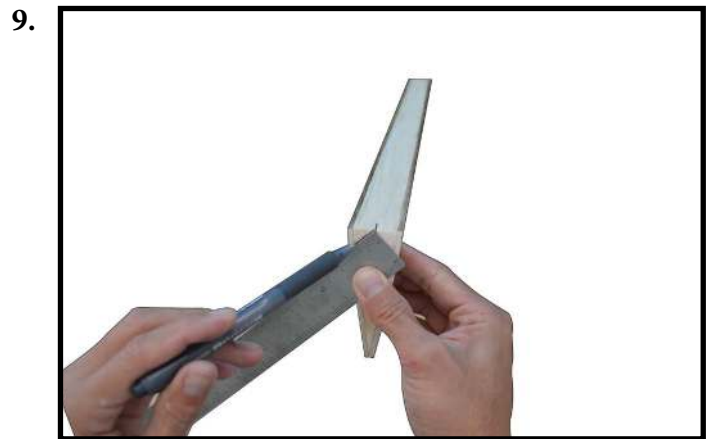

- Make mark angle 45 degree, toward side of control hole as photo (photo 9,10).



- Use sandpaper bar to sanding make the angle of flap.

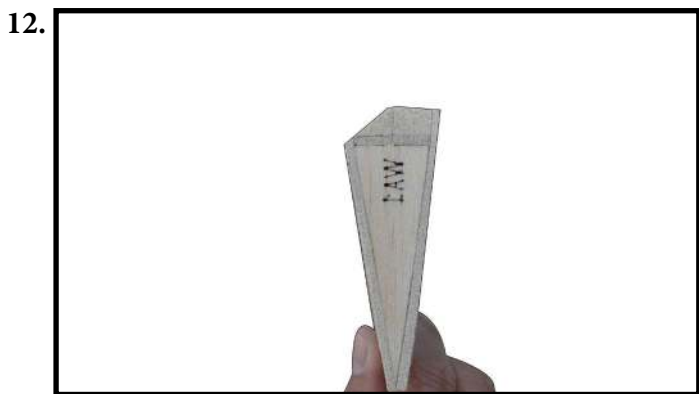

- The flap was finished.

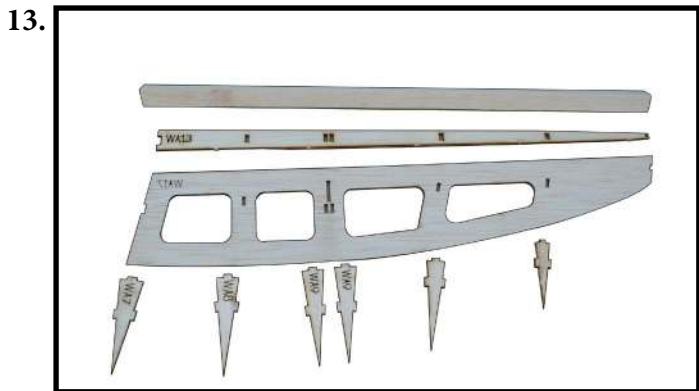

- Getting prepare set of aileron as photo.

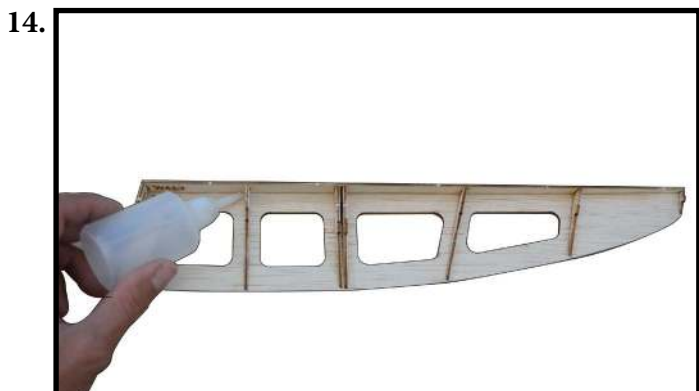

- Install the ribs of aileron to balsa sheet WA17 and leading edge of aileron WA13 by CA glue.

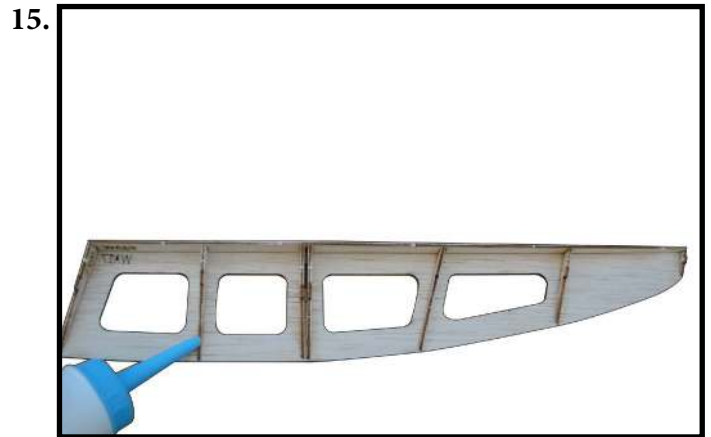

- Apply white glue to the ribs of aileron as photo.

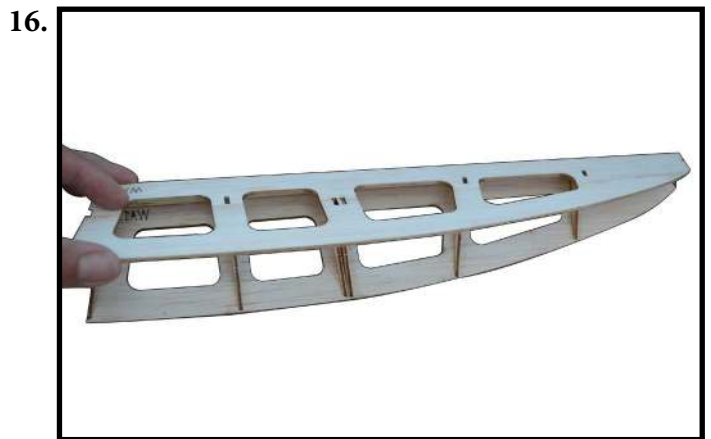

- Cover balsa sheet WA18 to the ribs of aileron

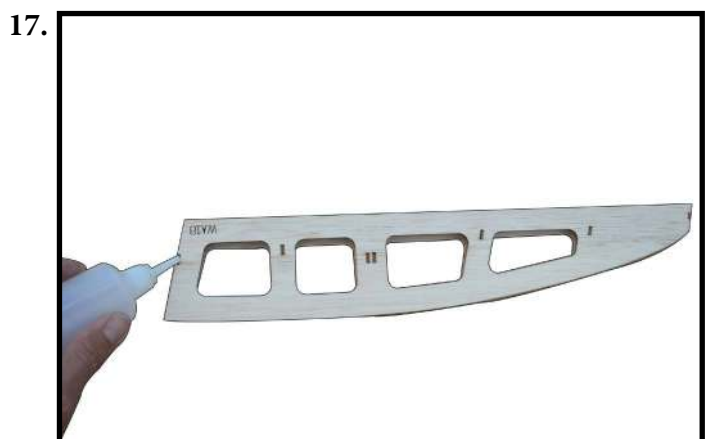

- Apply CA glue to keep fixed as photo.

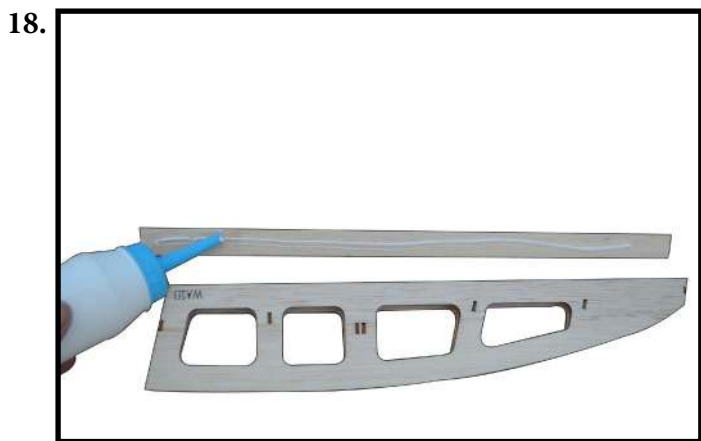

- Paste balsa block WA20 on leading edge of aileron by white glue.



- Use the pen make the mark of hinge on flap follow wing.

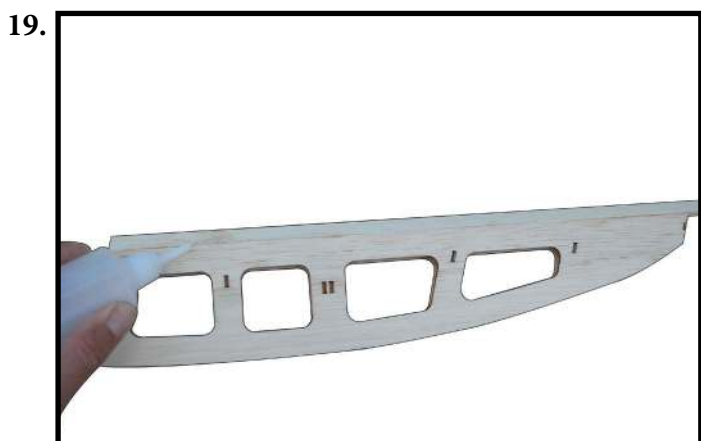

- Apply CA glue at leading edge WA20 with balsa sheet WA17 to keep fixed as photo.



- Use the pen make the mark of hinge on aileron follow wing.



- Use sandpaper bar for sanding leading edge WA20.



- Building the set of wing was finished.

HINGING THE FLAP

Note : *The control surfaces, including the ailerons, elevators, and rudder, are prehinged with hinges installed, but the hinges are not glued in place. It is imperative that you properly adhere the hinges in place per the steps that follow using a high-quality thin C/A glue.*

- Carefully remove the flap from one of the wing panels. Note the position of the hinges.

1.

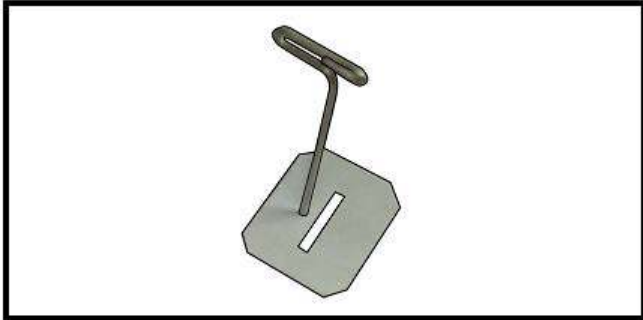

- Remove each hinge from the wing panel and flap and place a T-pin in the center of each hinge. Slide each hinge into the wing panel until the T-pin is snug against the wing panel. This will help ensure an equal amount of hinge is on either side of the hinge line when the flap is mounted to the aileron.

2.

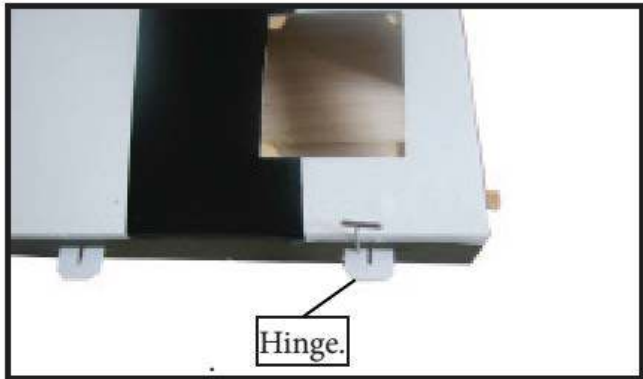

- Slide the wing panel on the flap until there is only a slight gap. The hinge is now centered on the wing panel and flap. Remove the T-pins and snug the aileron against the wing panel. A gap of 1/64" or less should be maintained between the wing panel and flap.

- Deflect the flap and completely saturate each hinge with thin C/A glue. The ailerons front surface should lightly contact the wing during this procedure. Ideally, when the hinges are glued in place, a 1/64" gap or less will be maintained throughout the length of the flap to the wing panel hinge line.

NOTE : The hinge is constructed of a special material that allows the C/A to wick or penetrate and distribute throughout the hinge, securely bonding it to the wood structure of the wing panel and flap.

3.



- Turn the wing panel over and deflect the flap in the opposite direction from the opposite side. Apply thin C/A glue to each hinge, making sure that the C/A penetrates into both the aileron and wing panel.

- Using C/A remover/debonder and a paper towel, remove any excess C/A glue that may have accumulated on the wing or in the flap hinge area.

- Repeat this process with the other wing panel, securely hinging the aileron in place.

- After both flap are securely hinged, firmly grasp the wing panel and aileron to make sure the hinges are securely glued and cannot be pulled out. Do this by carefully applying medium pressure, trying to separate the flap from the wing panel. Use caution not to crush the wing structure.

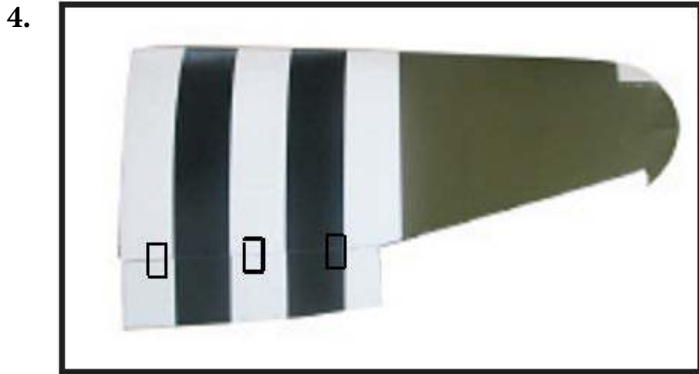

Note : Work the aileron up and down several times to “work in” the hinges and check for proper movement.

HINGING THE AILERON

Note : *The control surfaces, including the ailerons, elevators, and rudder, are prehinged with hinges installed, but the hinges are not glued in place. It is imperative that you properly adhere the hinges in place per the steps that follow using a high-quality thin C/A glue.*

- Carefully remove the aileron from one of the wing panels. Note the position of the hinges.

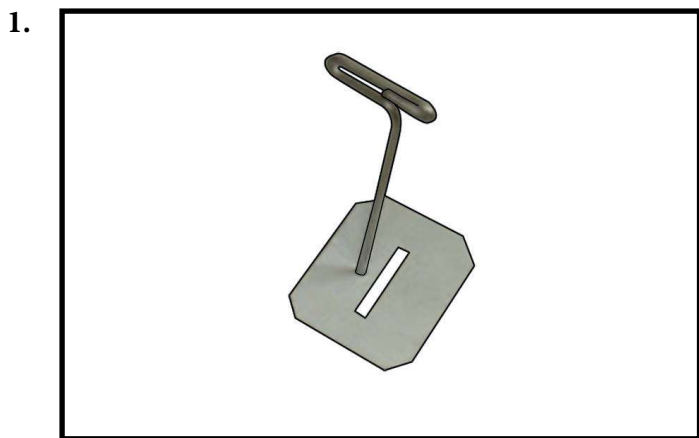

- Remove each hinge from the wing panel and aileron and place a T-pin in the center of each hinge. Slide each hinge into the wing panel until the T-pin is snug against the wing panel. This will help ensure an equal amount of hinge is on either side of the hinge line when the aileron is mounted to the aileron.

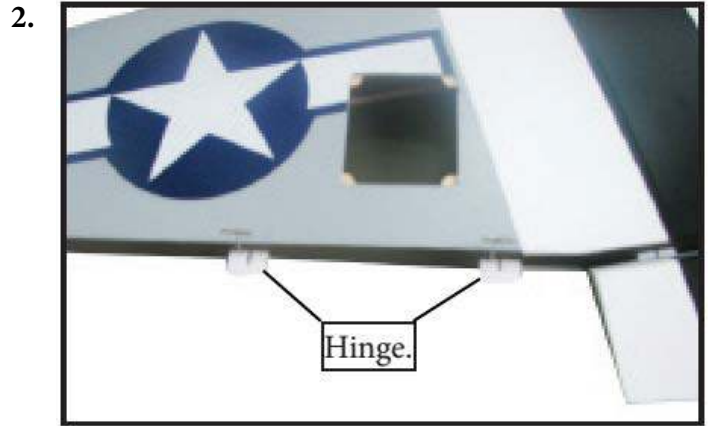

- Slide the wing panel on the aileron until there is only a slight gap. The hinge is now centered on the wing panel and aileron. Remove the T-pins and snug the aileron against the wing panel. A gap of 1/64” or less should be maintained between the wing panel and aileron.

- Deflect the aileron and completely saturate each hinge with thin C/A glue. The ailerons front surface should lightly contact the wing during this procedure. Ideally, when the hinges are glued in place, a 1/64” gap or less will be maintained throughout the length of the aileron to the wing panel hinge line.

NOTE : The hinge is constructed of a special material that allows the C/A to wick or penetrate and distribute throughout the hinge, securely bonding it to the wood structure of the wing panel and aileron.

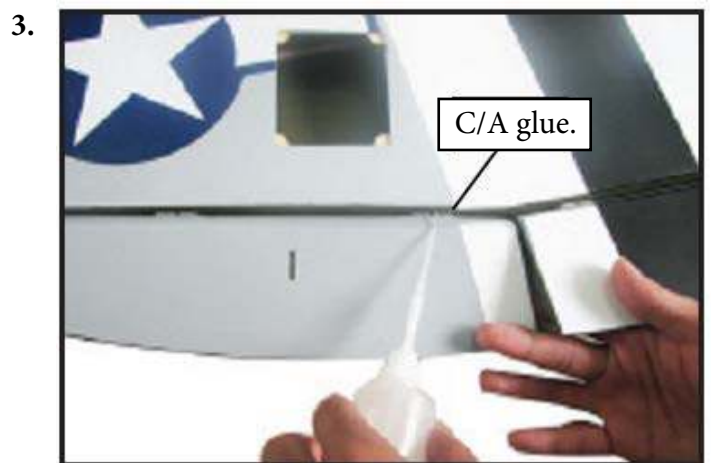

- Turn the wing panel over and deflect the aileron in the opposite direction from the opposite side. Apply thin C/A glue to each hinge, making sure that the C/A penetrates into both the aileron and wing panel.

- Using C/A remover/debonder and a paper towel, remove any excess C/A glue that may have accumulated on the wing or in the aileron hinge area.

- Repeat this process with the other wing panel, securely hinging the aileron in place.

- After both ailerons are securely hinged, firmly grasp the wing panel and aileron to make sure the hinges are securely glued and cannot be pulled out. Do this by carefully applying medium pressure, trying to separate the aileron from the wing panel. Use caution not to crush the wing structure.

2.



4.

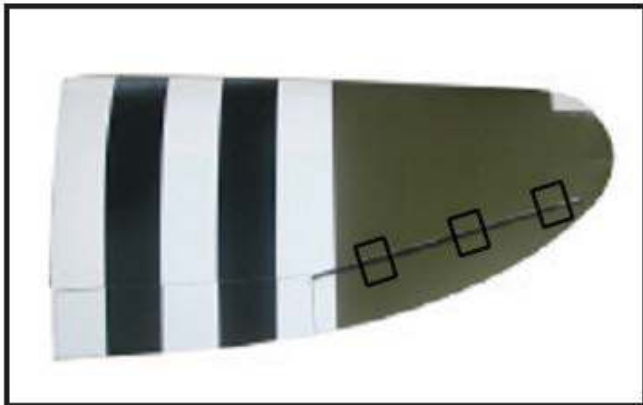

INSTALL FLAP CONTROL HORN

- Install the flap control horn using the same method as same as the aileron control horns.

1.



Fiberglass control horn.

Note: Work the aileron up and down several times to “work in” the hinges and check for proper movement.

INSTALL THE AILERONS CONTROL HORN

1.



2.

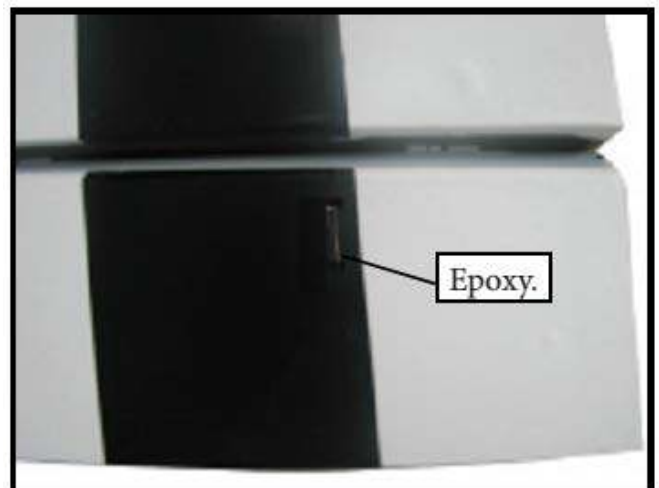

INSTALLING THE AILERON SERVOS

1.

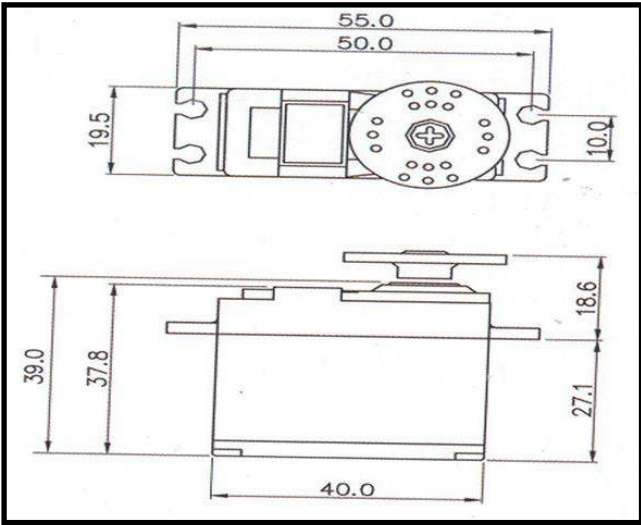

2.

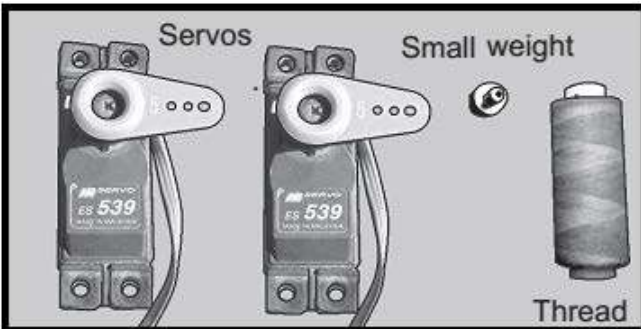

Minimum servo spec.
Torque : 80 oz-in (5.8 kg-cm) @ 4.8V; 100 oz-in (7.2 kg-cm) @ 6.0V

⚠ Because the size of servos differ, you may need to adjust the size of the precut opening in the mount. The notch in the sides of the mount allow the servo lead to pass through.

- Using a small weight (Weighted fuel pick-up works well) and string, feed the string through the wing as indicated.

- Place the servo between the mounting blocks and space it from the hatch. Use a pencil to mark the mounting hole locations on the blocks.

3.

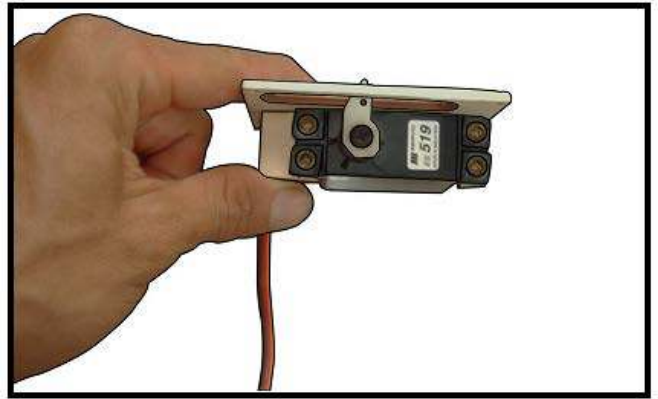

- Use drill bit in a pin vise to drill the mounting holes in the blocks.

4.

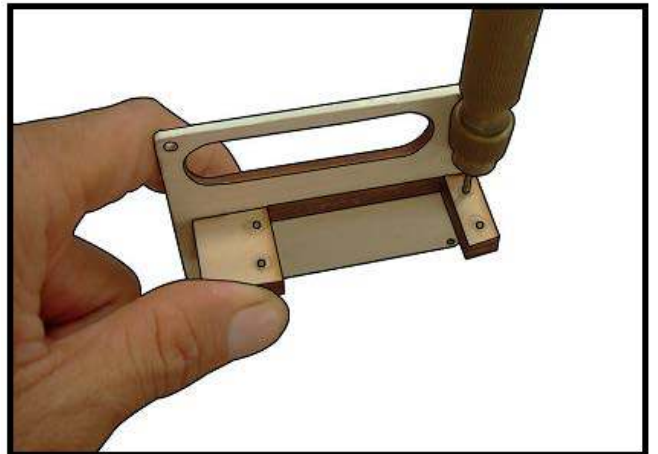

- A string has been provided in the wing to pull the aileron lead through to the wing root. Remove the string from the wing at the servo location and use the tape to attach it to the servo extension lead. Pull the lead through the wing and remove the string.

5.

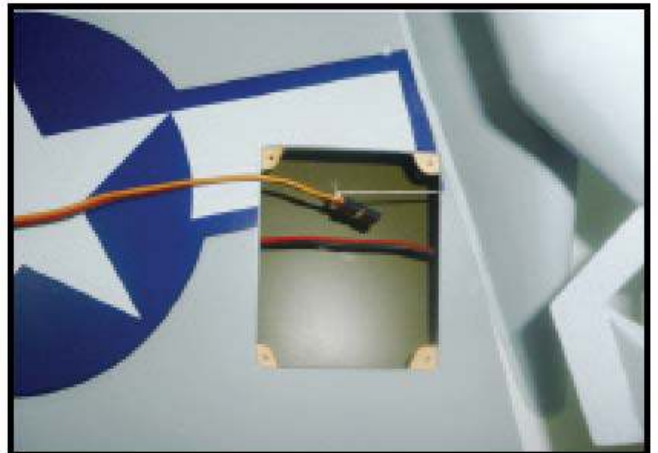

INSTALLING THE LIGHT COVER

- Please see below pictures.

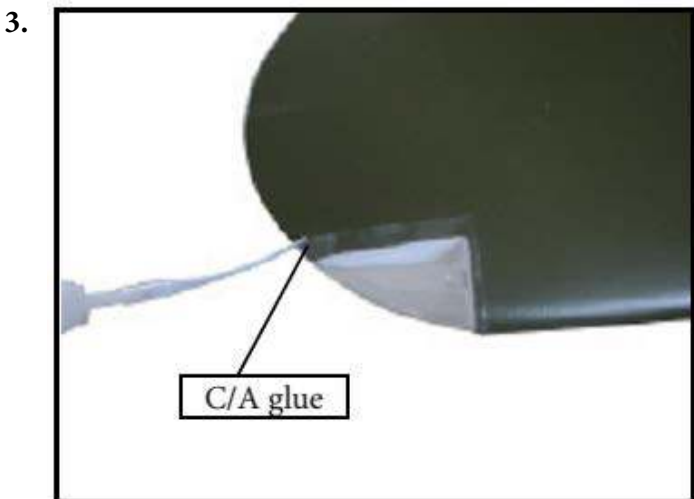
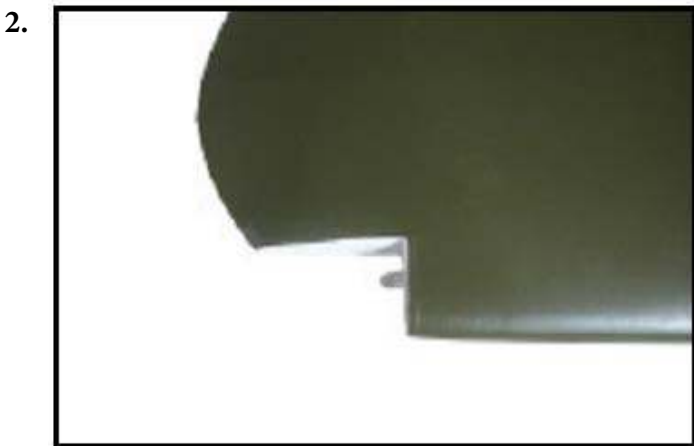

AILERON PUSHROD INSTALLATION

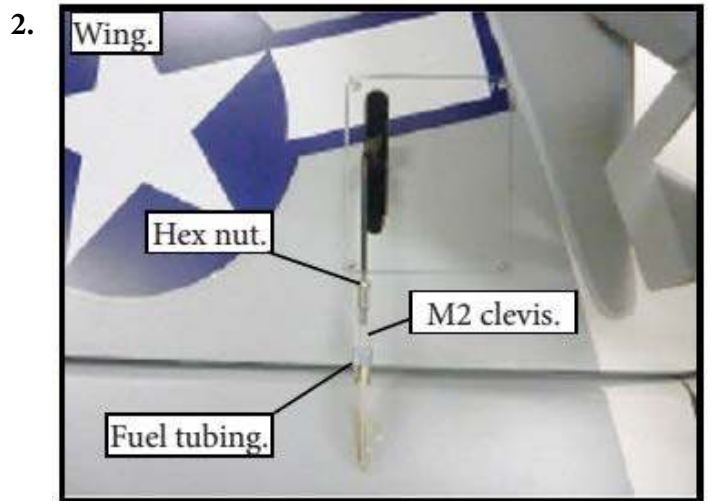
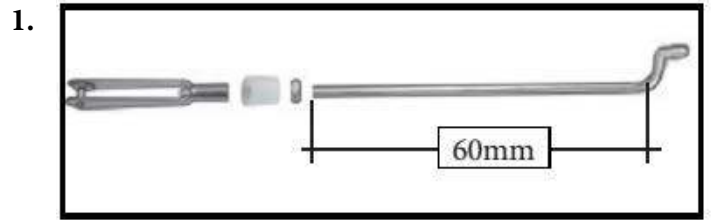

INSTALLING THE FLAP PUSHROD

- Repeat the procedure for the aileron pushrod.

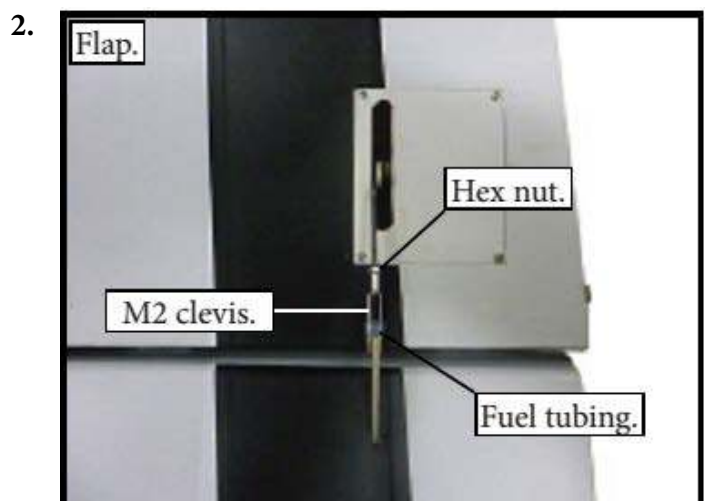
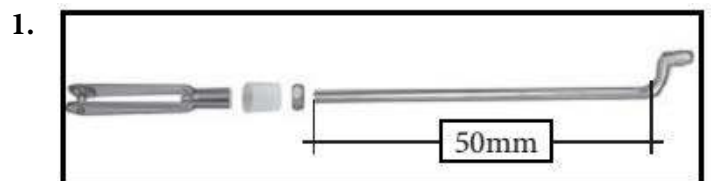

INSTALLING RETRACTABLE LANDING GEAR

- Locate the items necessary to install the retractable landing gear as shown.

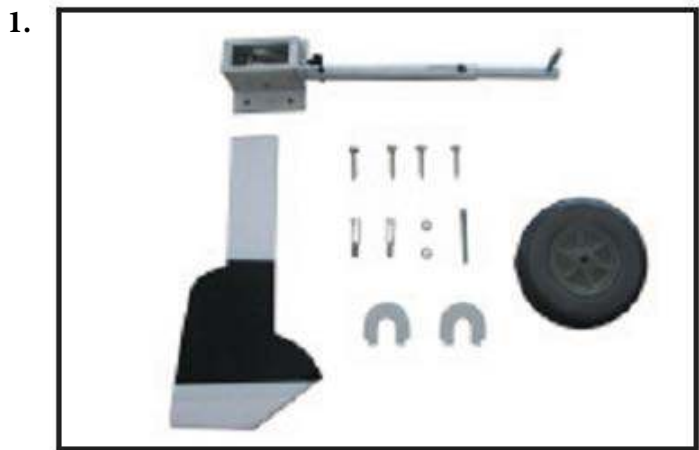

- Install retractable landing gear at the Wing.

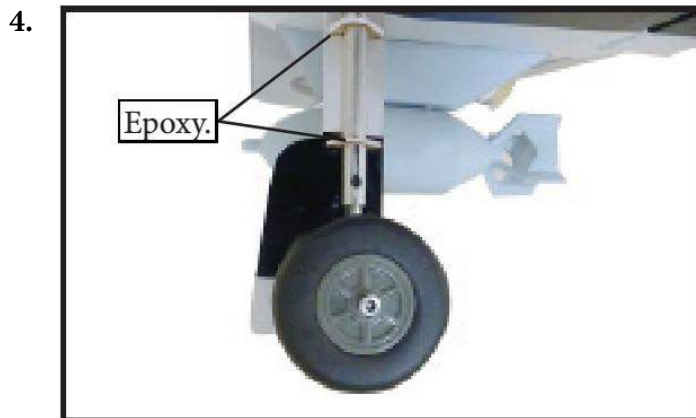
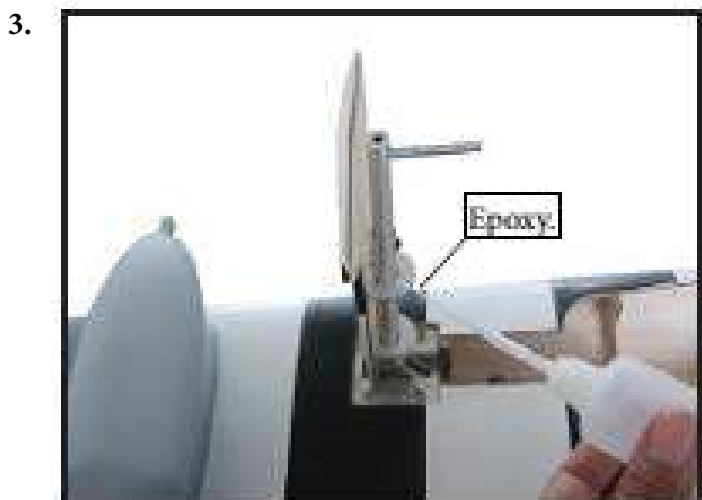
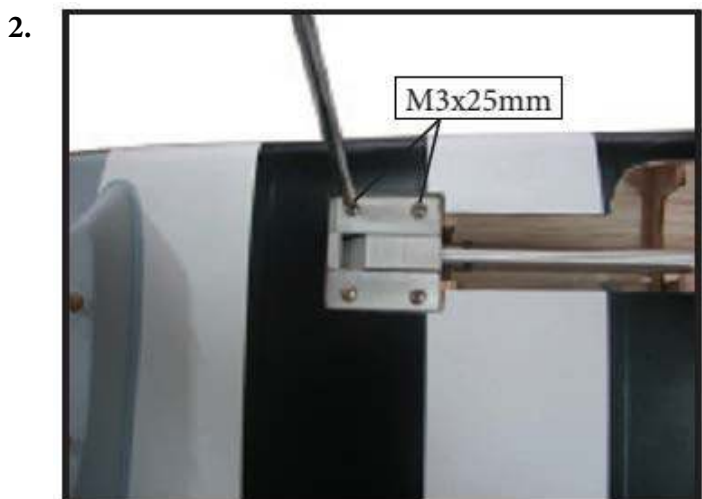

RETRACTABLE LANDING GEAR SERVO - PUSHROD INSTALLATION

- Locate items necessary to install landing gear pushrod.

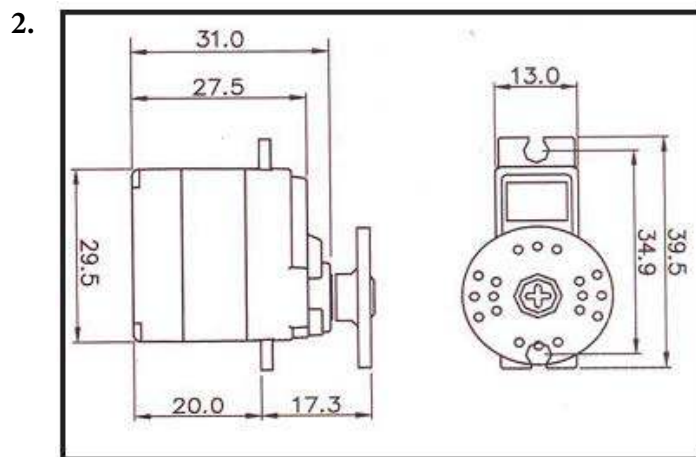
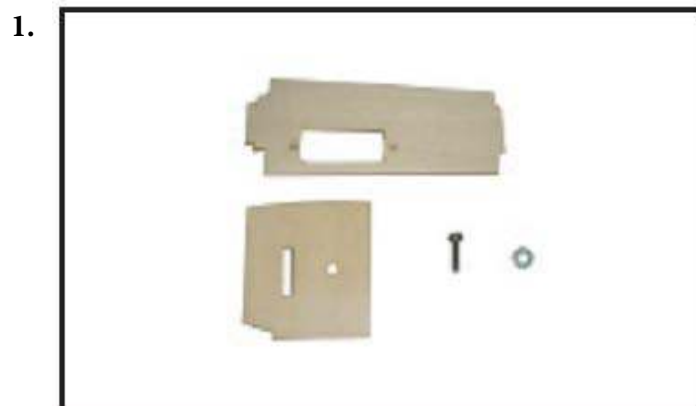

3.

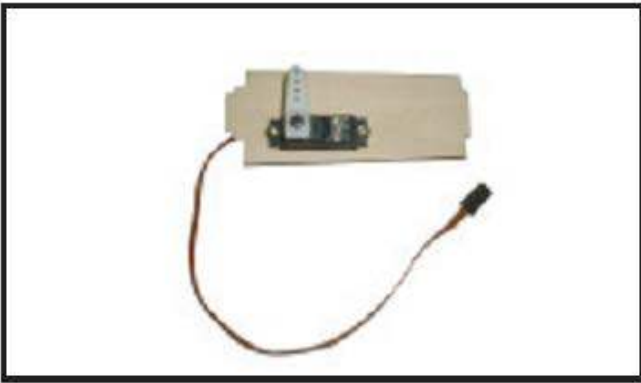

4.

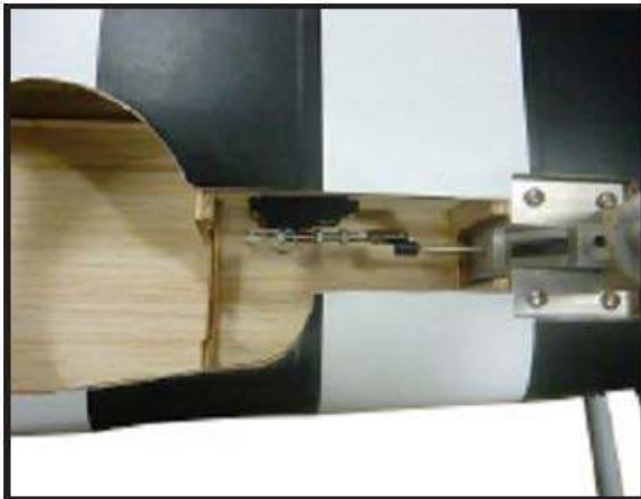

5.

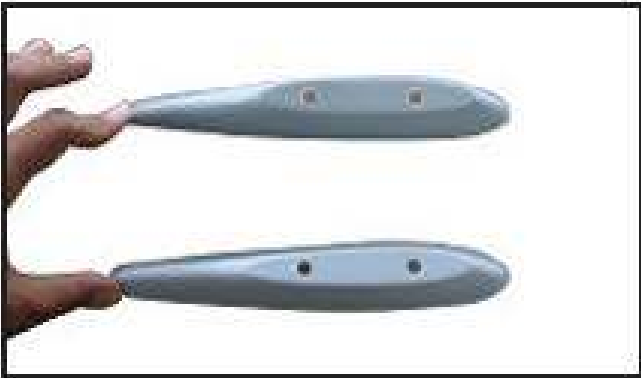

6.

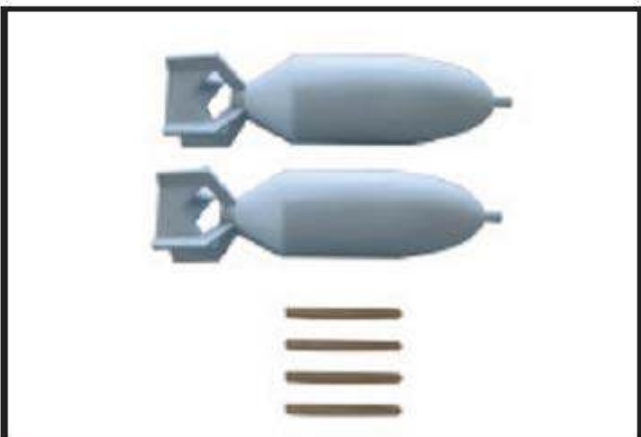

7.

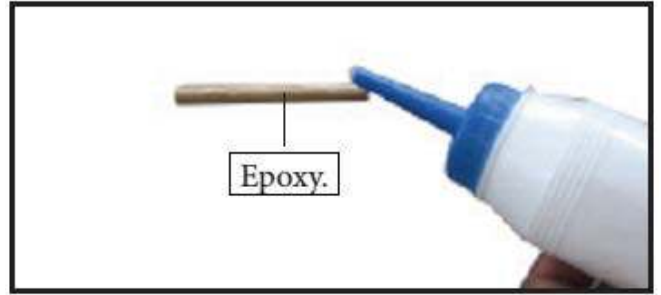

8.



9.

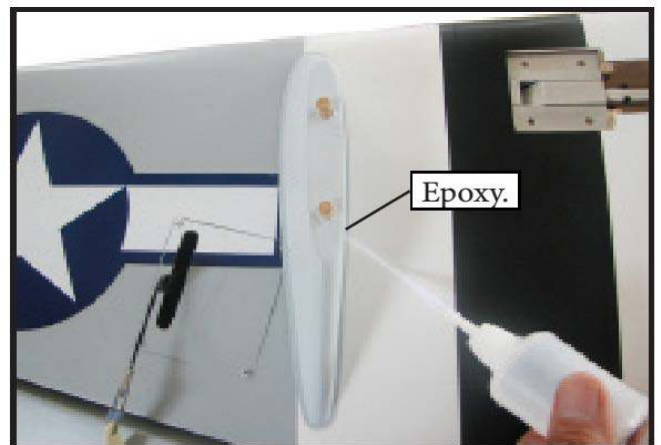

10.

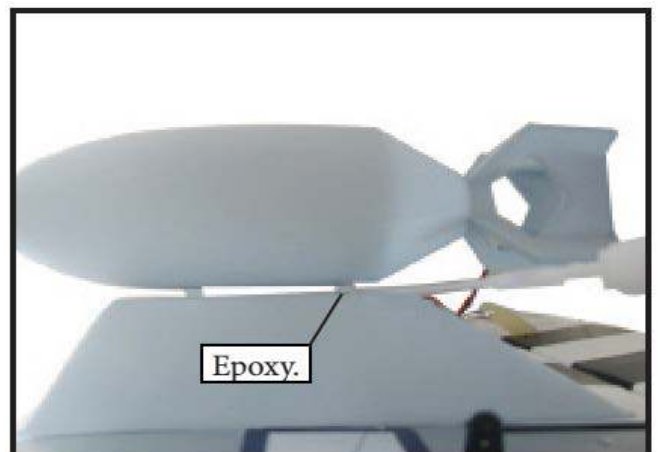

BUILD THE HORIZONTAL STAB

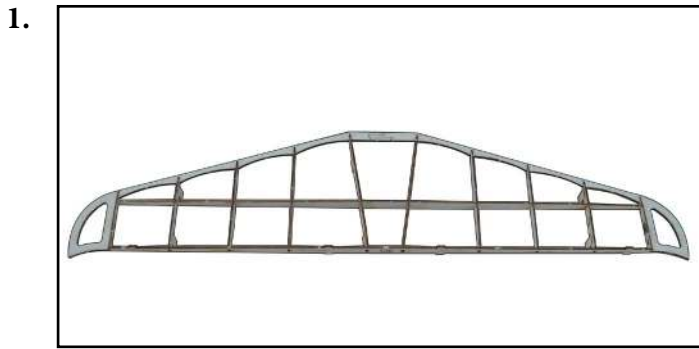

- Install the ribs of stabilizer as photo.

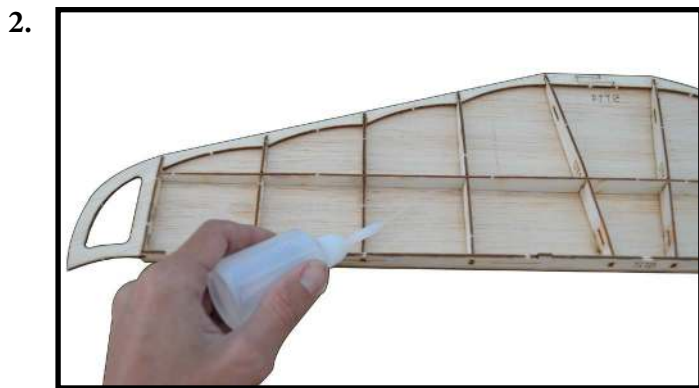

- Cover balsa sheet ST14 for 1st side by white glue and then apply CA glue to keep fixed.

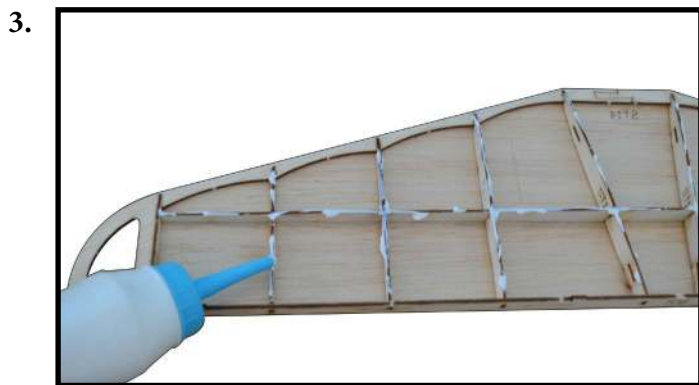

- Cover balsa sheet ST14 for 2nd side by white glue and then apply CA glue to keep fixed.

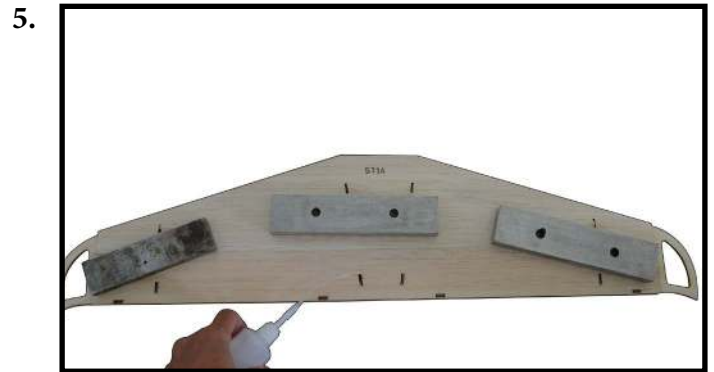

- Hold the sheet down with weights while the glue dries and apply CA/glue to the sheet at trailing edge.

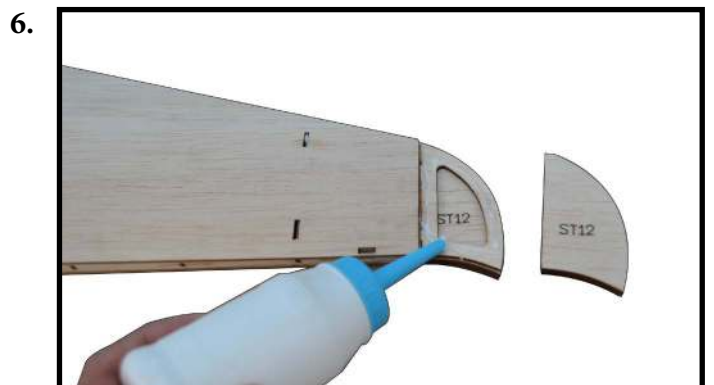

- Install the 6mm balsa block ST12 by white glue as photo and then apply CA glue to keep fixed (photo 6,7)



- Use cutter to sharpen the ST12 for flattening surface of stabilizer.



- Use sandpaper bar for sanding the surface of stabilizer.



- Building the stabilizer was finished.

BUILD THE ELEVATOR

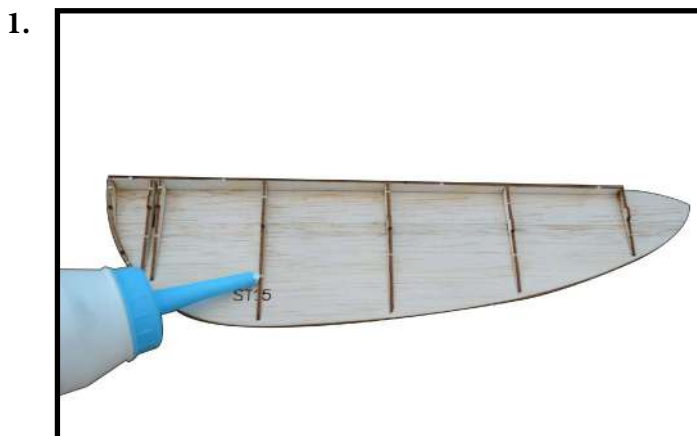

- Install the ribs of elevator to balsa sheet ST15 and leading edge of elevator ST13 by white glue.



- Apply white glue to the ribs of elevator and cover the balsa sheet ST15' as photo.

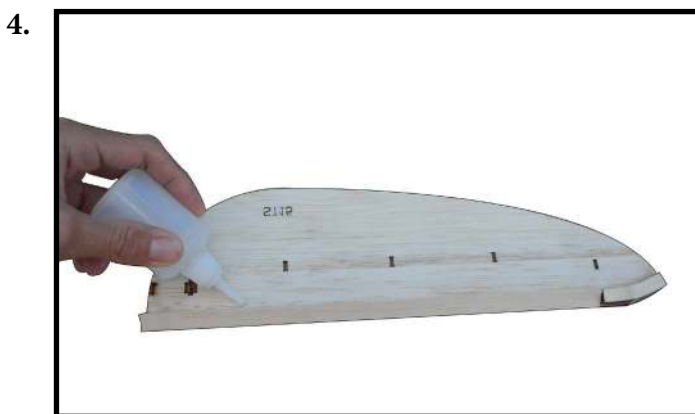
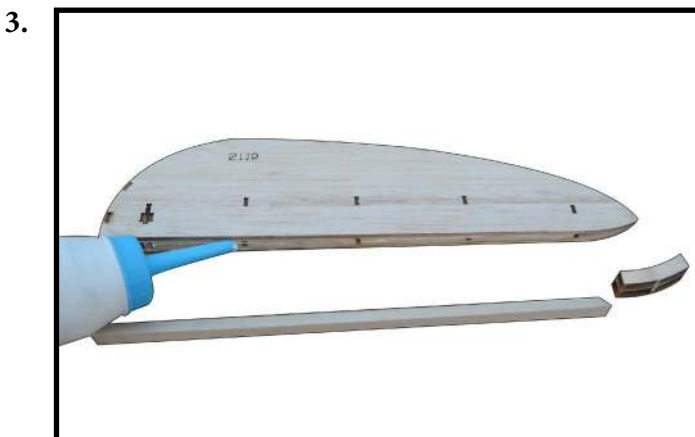

- Apply white glue to leading edge so that attaching triangle balsa block and 6mm balsa block ST16.

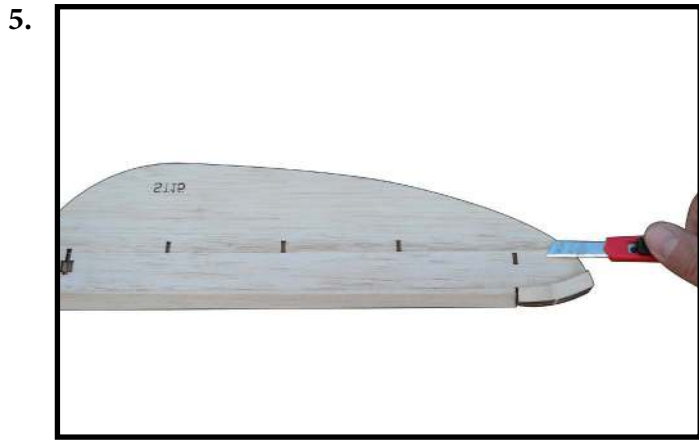

- Use cutter knife to sharpen the ST16 for flattening surface of elevator.

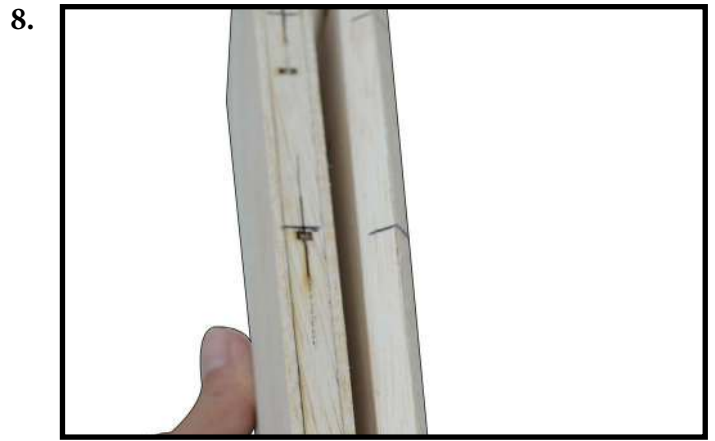

- Use the pen make the mark of hinge on elevator follow stabilizer.



- Use sandpaper bar for sanding leading edge and ST15.

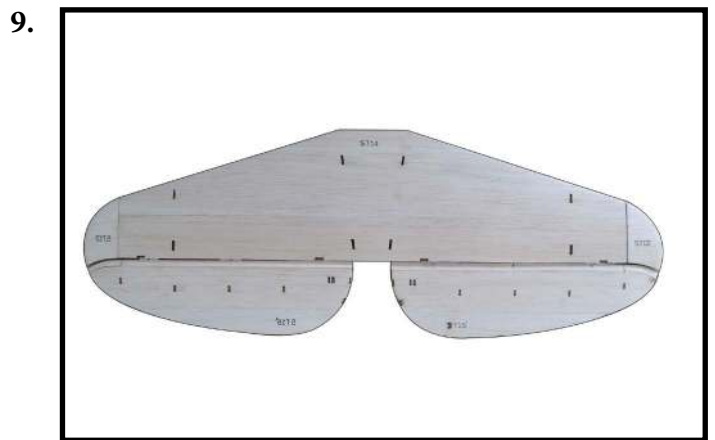

- Set of Stab and elevator was built .

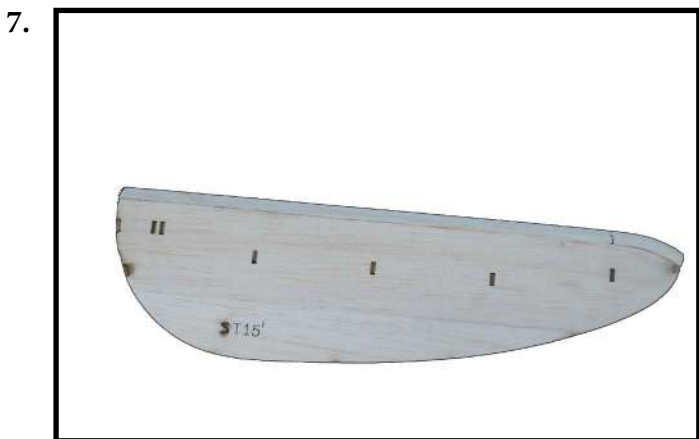

- Building elevator was finished.

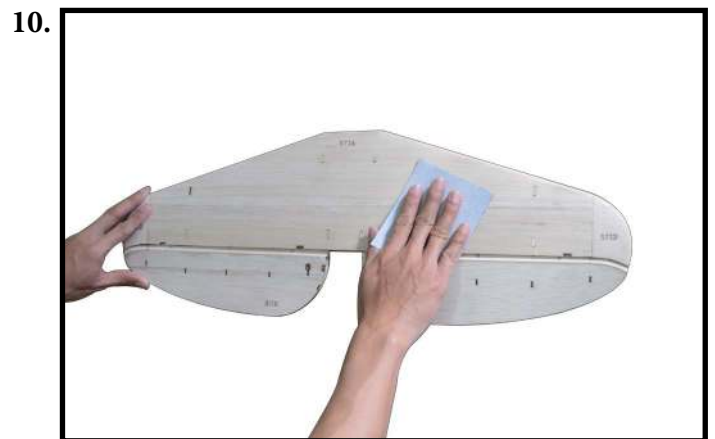

- Use sandpaper to sanding around set of stab and elevator.

HINGING THE ELEVATORS

- Glue the elevator hinges in place using the same techniques used to hinge the ailerons.

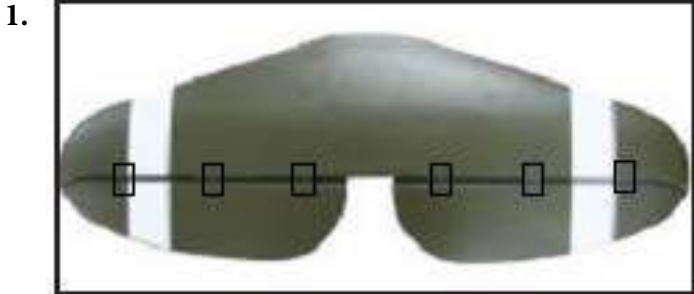

INSTALL ELEVATOR CONTROL HORN

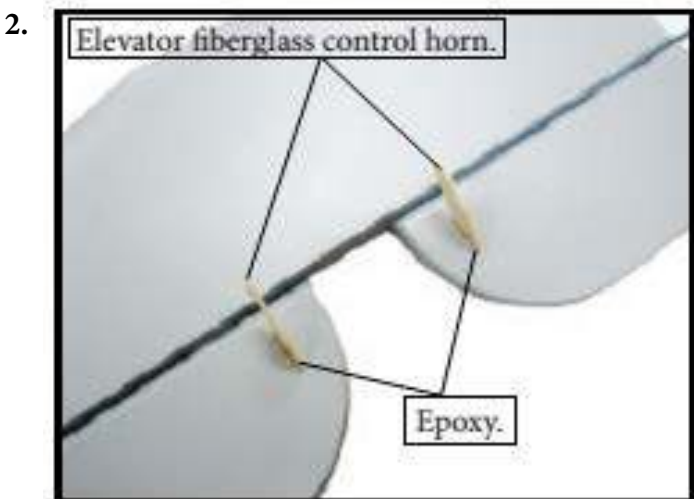

INSTALLING THE HORIZONTAL STABILIZER

- Using a ruler and a pen, locate the centerline of the horizontal stabilizer, at the trailing edge, and place a mark. Use a triangle and extend this mark, from back to front, across the top of the stabilizer. Also extend this mark down the back of the trailing edge of the stabilizer.

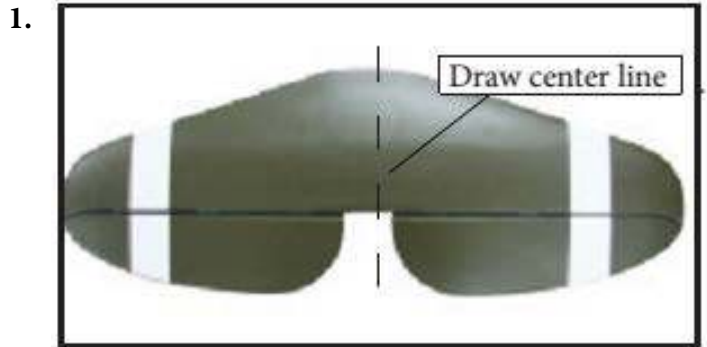

- Using a modeling knife, carefully remove the covering at mounting slot of horizontal stabilizer (both side of fuselage).



- Slide the stabilizer into place in the precut slot in the rear of the fuselage. The stabilizer should be pushed firmly against the front of the slot.

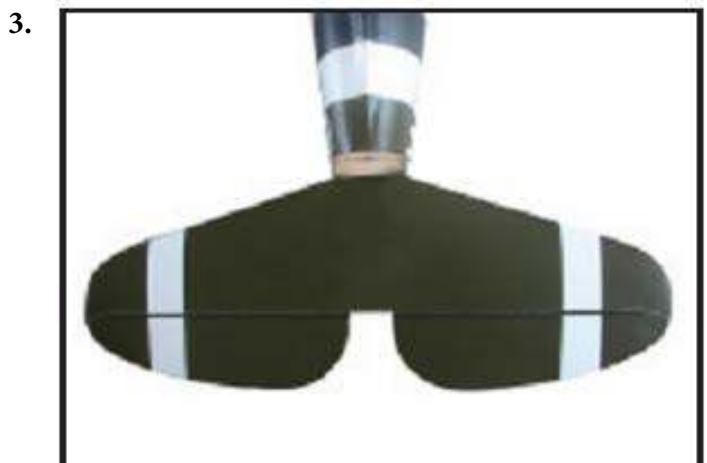

- With the stabilizer held firmly in place, use a pen and draw lines onto the stabilizer where it and the fuselage sides meet. Do this on both the right and left sides and top and bottom of the stabilizer.



- Remove the stabilizer. Using the lines you just drew as a guide, carefully remove the covering from between them using a modeling knife.

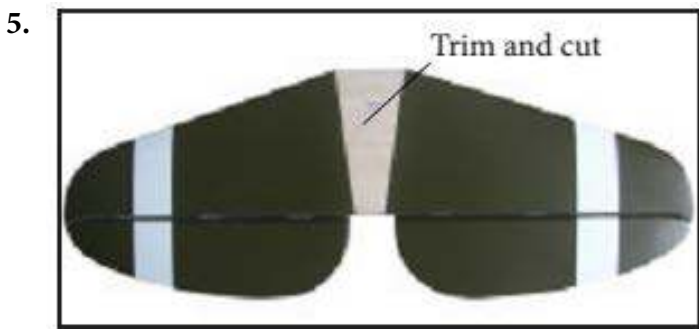

! *When cutting through the covering to remove it, cut with only enough pressure to only cut through the covering itself. Cutting into the balsa structure may weaken it.*

- Using a modeling knife, carefully remove the covering that overlaps the stabilizer mounting platform sides in the fuselage. Remove the covering from both the top and the bottom of the platform sides.



- When you are sure that everything is aligned correctly, mix up a generous amount of 30 Minute Epoxy. Apply a thin layer to the top and bottom of the stabilizer mounting area and to the stabilizer mounting platform sides in the fuselage. Slide the stabilizer in place and realign. Double check all of your measurements once more before the epoxy cures. Hold the stabilizer in place with T-pins or masking tape and remove any excess epoxy using a paper towel and rubbing alcohol.



BUILD THE RUDDER

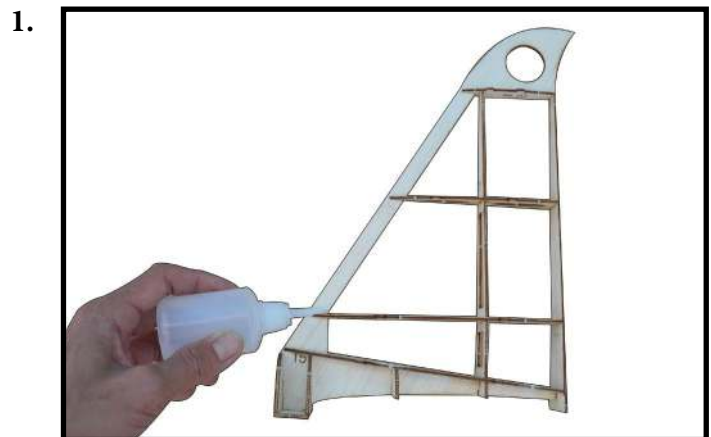

- Install the ribs of ruder to 1st balsa sheet ST19 and leading edge of rudder ST5 by CA glue as photo.

2.

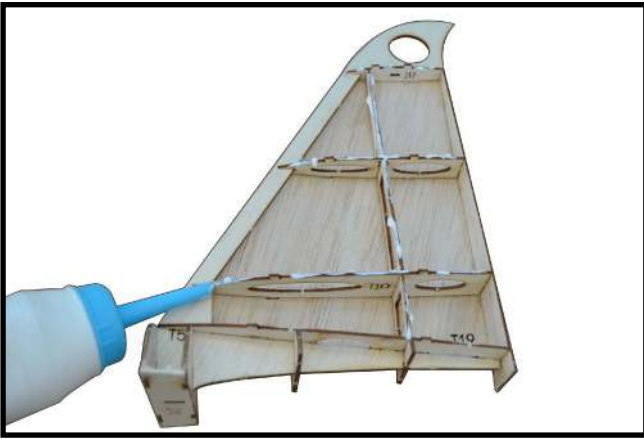

- Apply white glue to the ribs of rudder.

5.

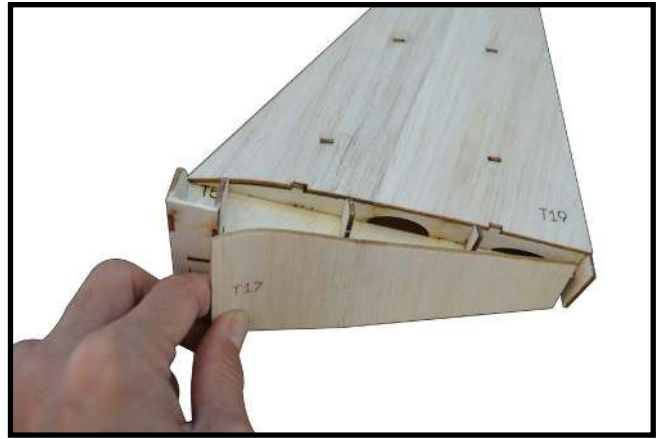

- Cover balsa sheet T17 at bottom of rudder as photo.

3.



- Cover 2nd balsa sheet T19 to the ribs of rudder.

6.

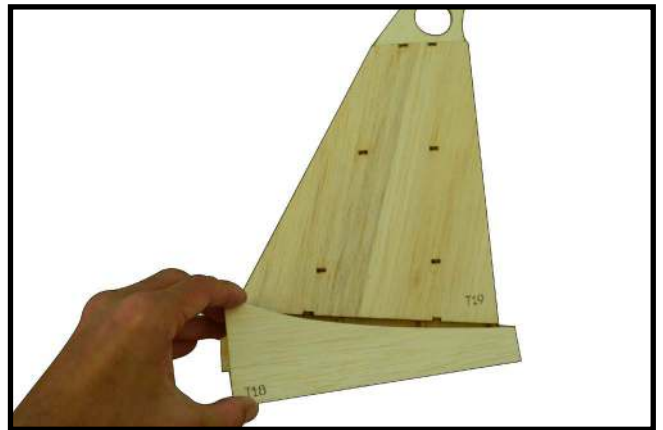

- Cover balsa sheet T18 for two side as photo.

4.



- Apply CA glue at the tabs show on the sheet to keep fixed.

7.





- Attach 8mm balsa block for two side by CA glue as photo.



- Use sandpaper bar for sanding the surface of rudder.

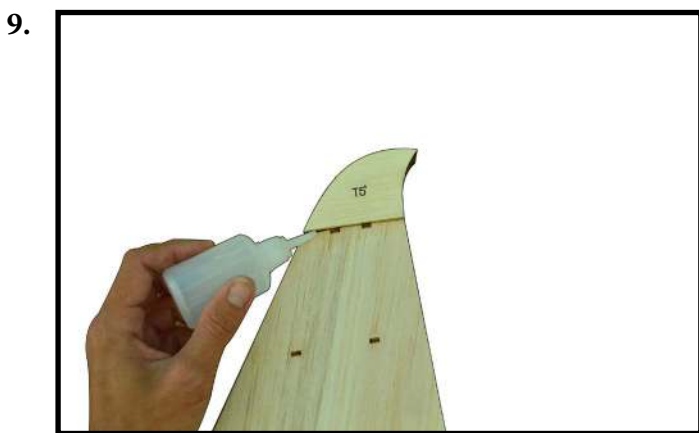

- Attach 8mm balsa block T5' by CA glue as photo.



- Building the rudder was finished.

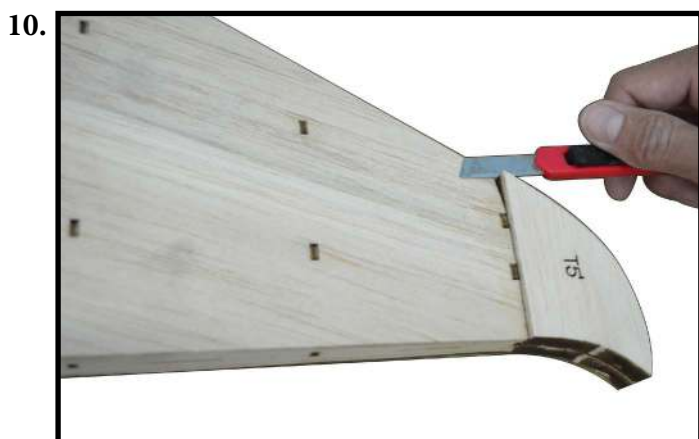

- Use a cutter to sharpen the T5' for flattening surface of rudder.

BUILD THE FIN



2.

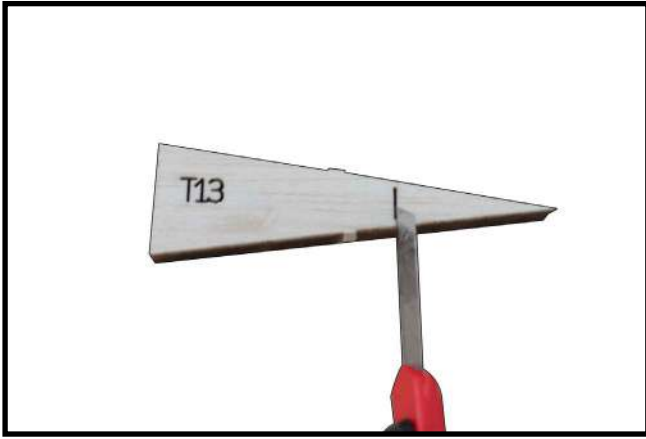

5.

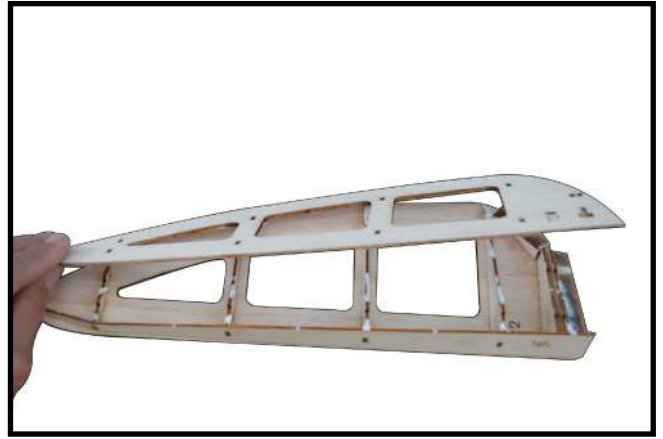

3.

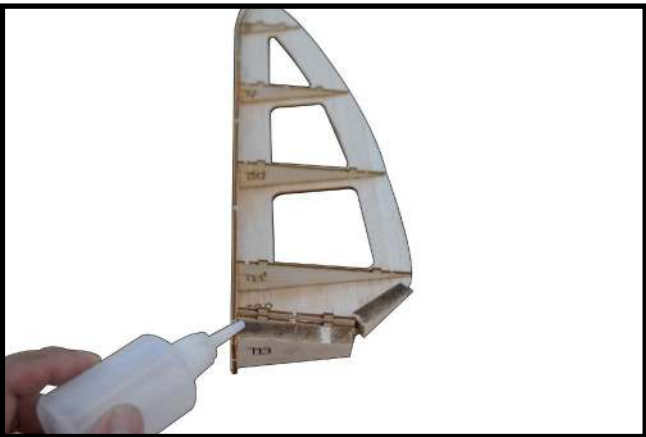

- Install the ribs of fin to balsa sheet T22 and leading edge of fin T15 and then attach 6mm balsa block T13 by CA glue as photo.

6.

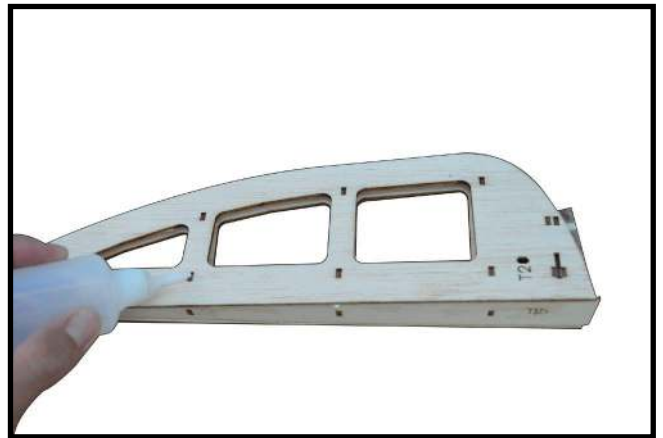

- Apply CA glue at the tabs show on the sheet to keep fixed.

4.

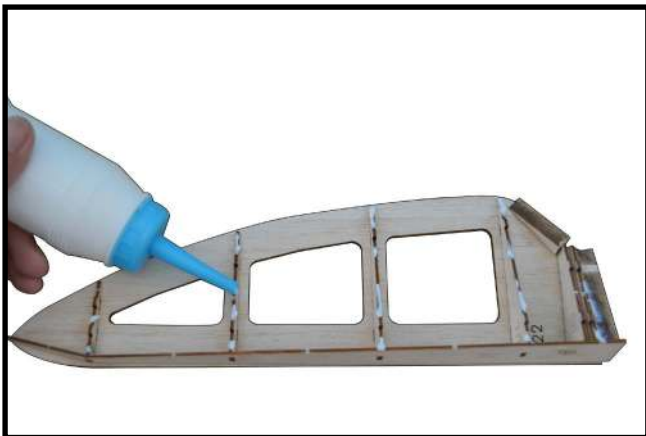

- Apply white glue to the ribs of fin.

7.

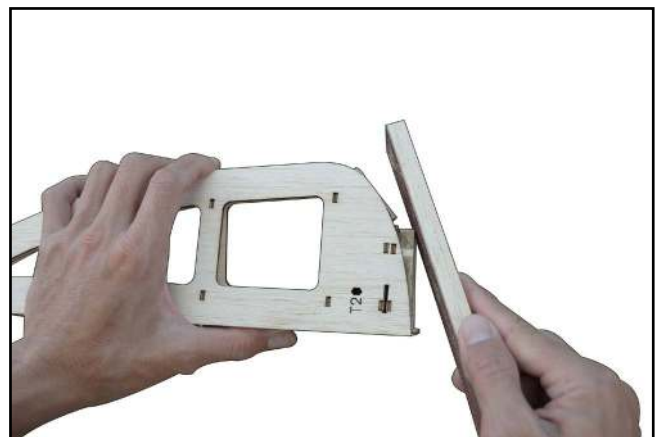

- Use sandpaper bar for sanding at T13 for making the shape round as the sheet.

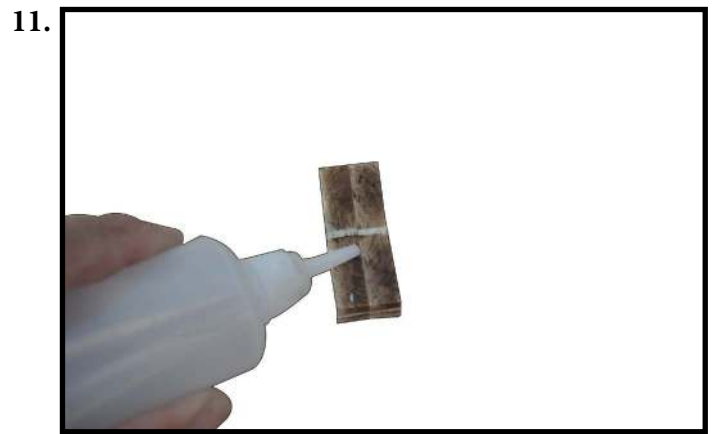
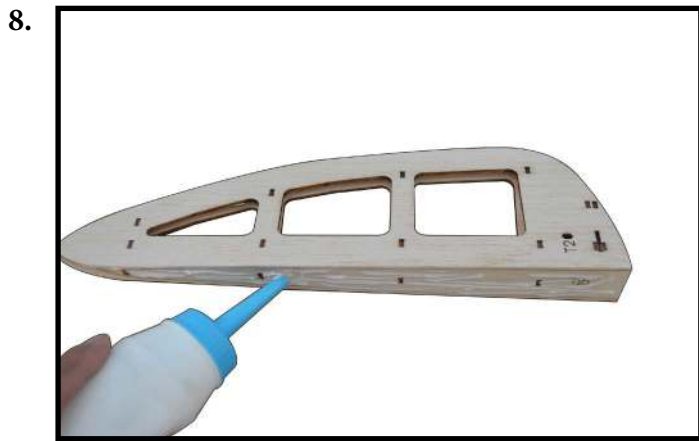

- Apply white glue to leading edge so that triangle balsa block.

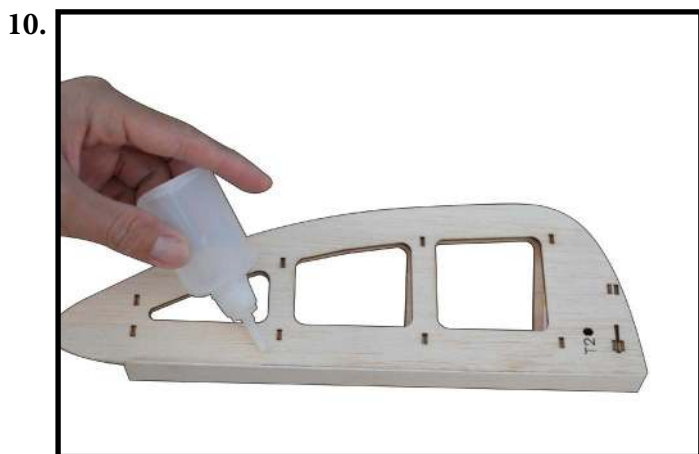
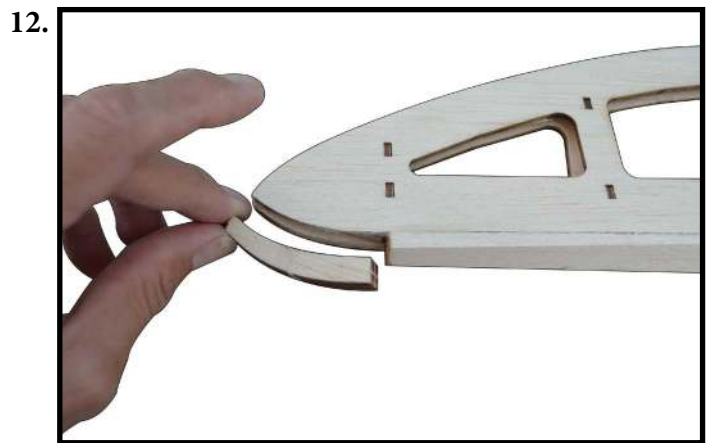

- Apply CA glue to keep fixed triangle balsa block.



- Attach to leading edge of fin by CA glue as photo.



- Use cutter knife to sharpen the T21 for flattening surface of fin.

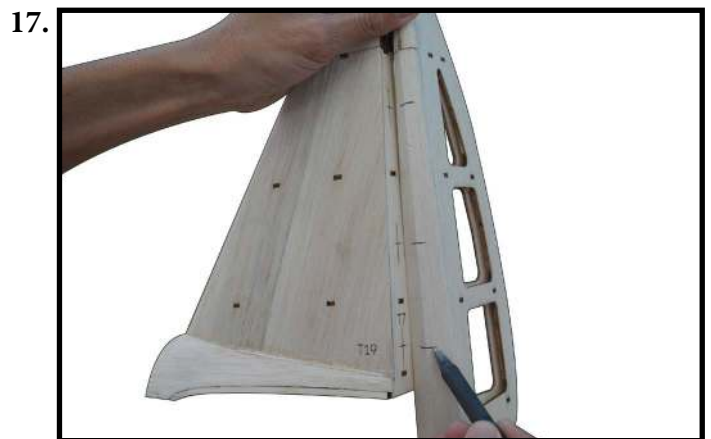

- Use the pen make the mark of hinge on the fin follow rudder.



- Use sandpaper bar for sanding around the fin.

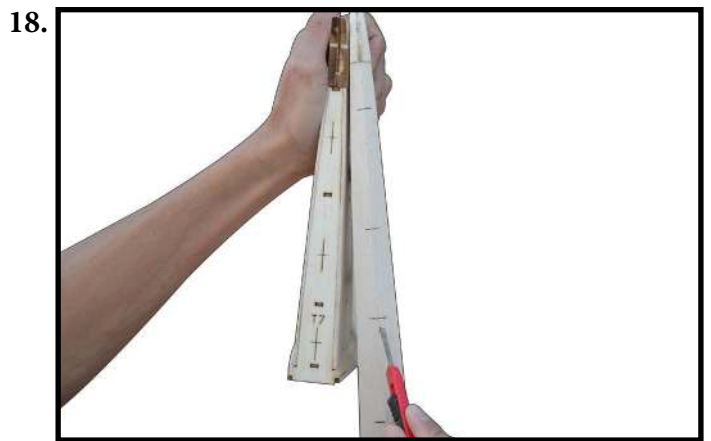

- Use the cutter knife cut off a slot for hinge.



- Building the fin was finished.



- Set of rudder and fin was finished.

20

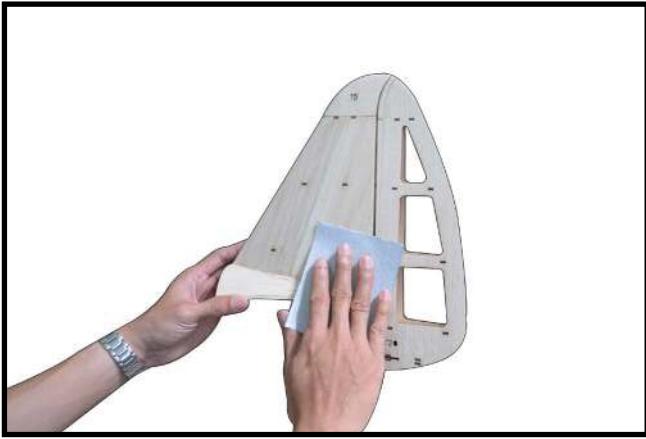

- Use sandpaper to sanding around set of rudder and fin.

3.

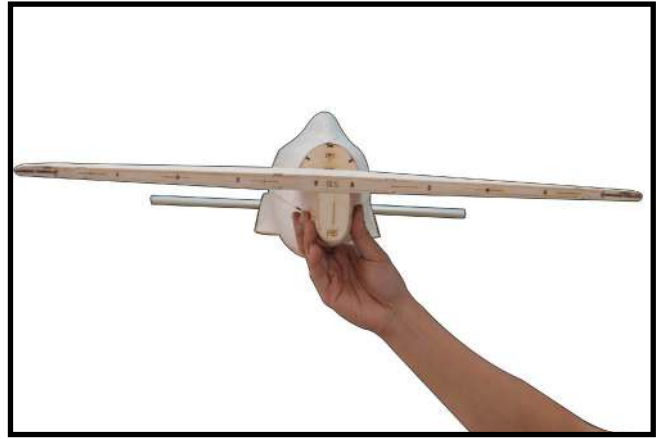

- Put the stabilizer and continue to sanding until fitting, there no slit at here. At the same time, the stabilizer and the wing tube have to parallel together.

SET UP THE KIT

1.

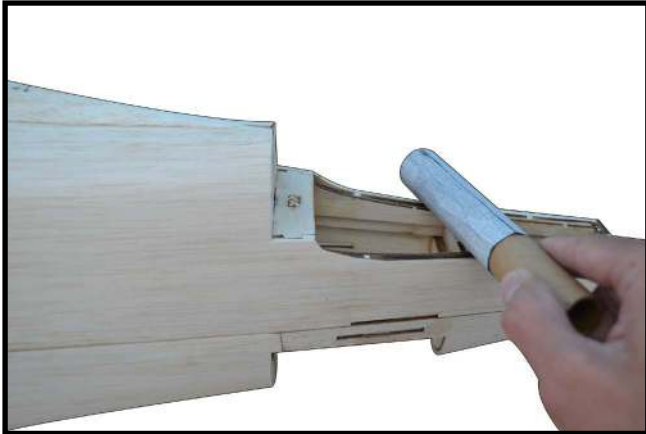

- Use sandpaper tube for sanding the area where install stabilizer.

4.

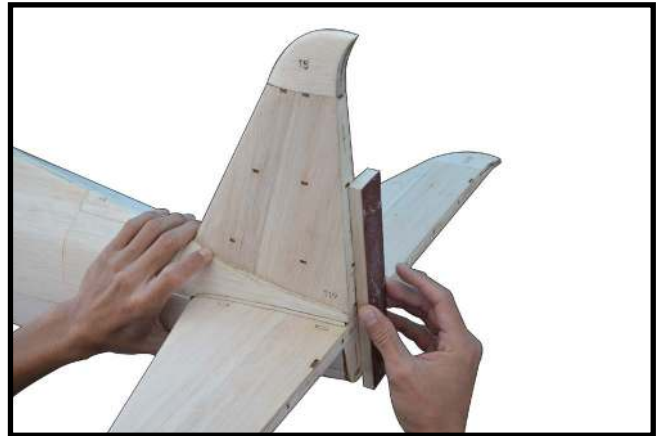

5.



- Put the rudder on the stabilizer and then use sandpaper bar to sanding area end fuselage include end of rudder, end of stabilizer, until there no rough. Use the ruler to test as photo.

2.



6.

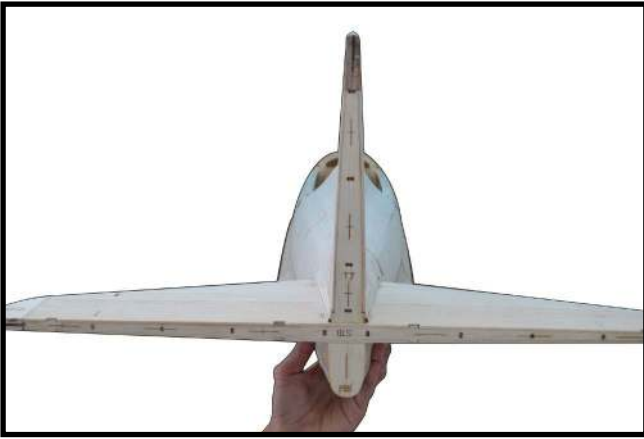

- Set up the kit was finished.

HINGING THE RUDDER

- Glue the rudder hinges in place using the same techniques used to hinge the ailerons.

1.



INSTALL RUDDER CONTROL HORN

- Repeat steps to install the rudder control horn as same as steps done for ailerons.

1.

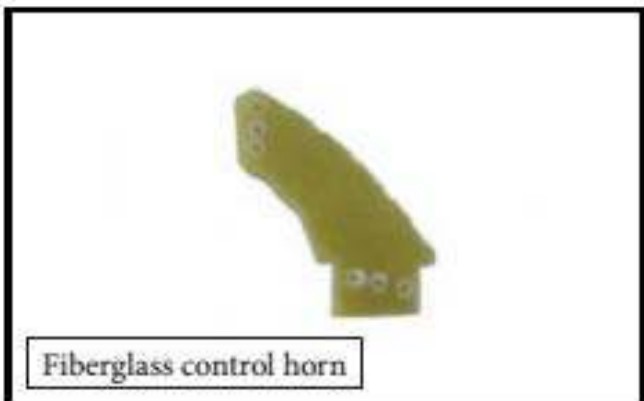

2.



INSTALLING VERTICAL STABILIZER

1.



- Using a modeling knife, remove the covering from over the precut hinge slot cut into the lower rear portion of the fuselage.

2.



- While holding the vertical stabilizer firmly in place, use a pen and draw a line on each side of the vertical stabilizer where it meets the top of the fuselage.

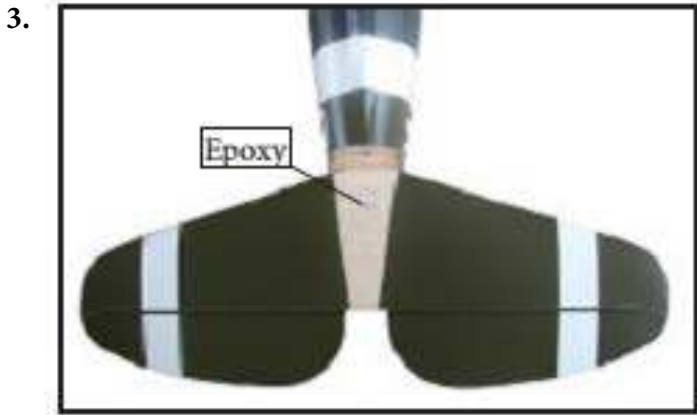

- Slide the vertical stabilizer back in place. Using a triangle, check to ensure that the vertical stabilizer is aligned 90° to the horizontal stabilizer.

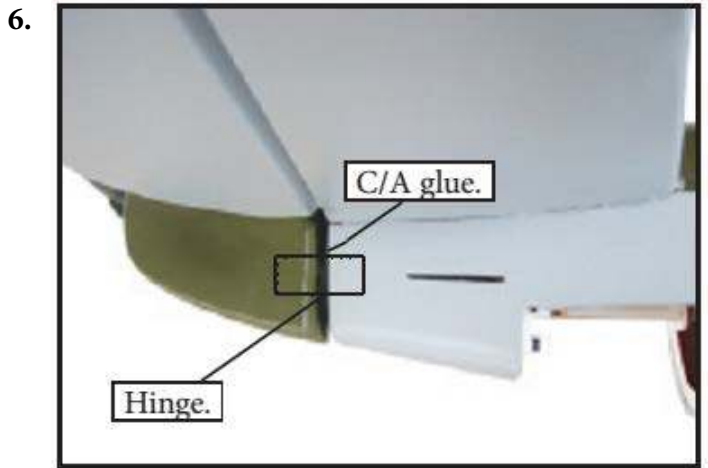
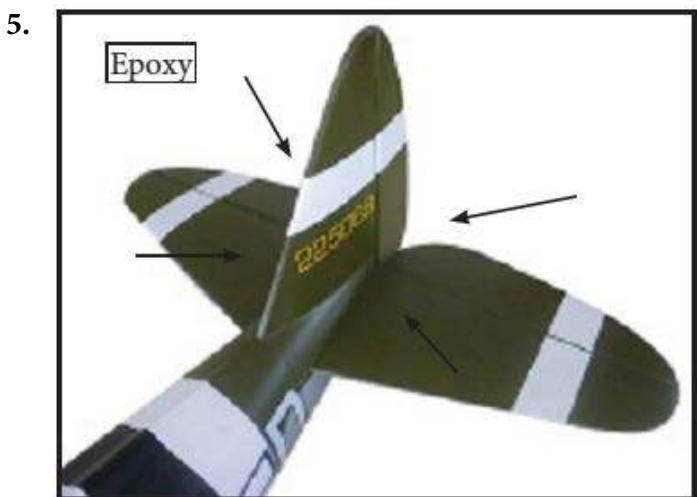
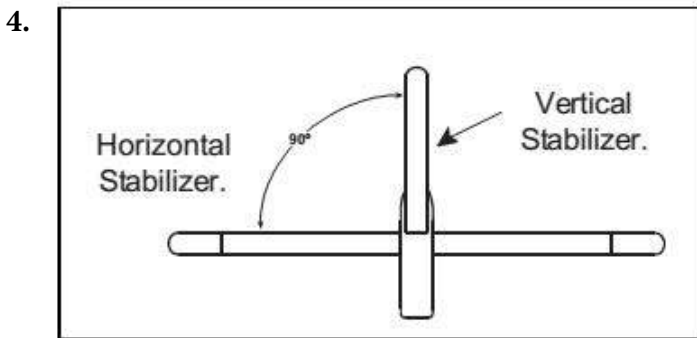

- When you are sure that everything is aligned correctly, mix up a generous amount of Flash 30 Minute Epoxy. Apply a thin layer to the mounting slot and to bottom of the vertical stabilizer mounting area. Apply epoxy to the bottom and top edges of the filler block and to the lower hinge also. Set the stabilizer in place and realign. Double check all of your measurements once more before the epoxy cures. Hold the stabilizer in place with T-pins or masking tape and remove any excess epoxy using a paper towel and rubbing alcohol. Allow the epoxy to fully cure before proceeding.

ELEVATOR PUSHROD INSTALLATION

- Locate items necessary to install rudder pushrod.

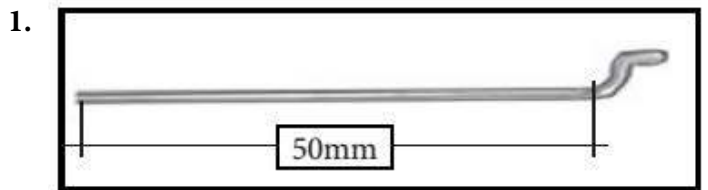

- Install the elevator control horn using the same method as with the aileron control horns.

- Position the elevator control horn on the both side of elevator.

2.

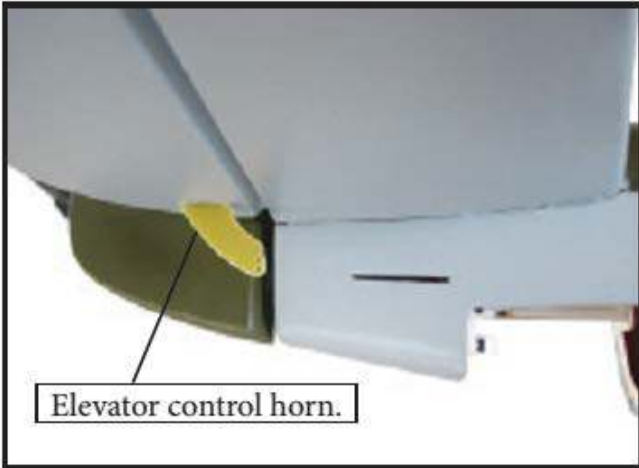

- Thread one clevis and M2 lock nut on to each elevator control rod. Thread the horns on until they are flush with the ends of the control rods.

- Elevator and rudder pushrods assembly as pictures below.

3.

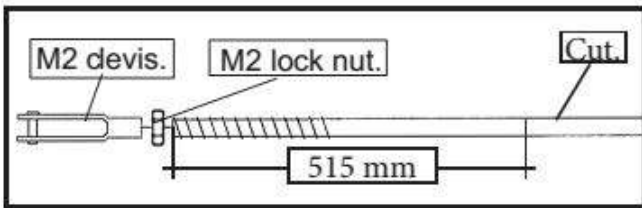

4.

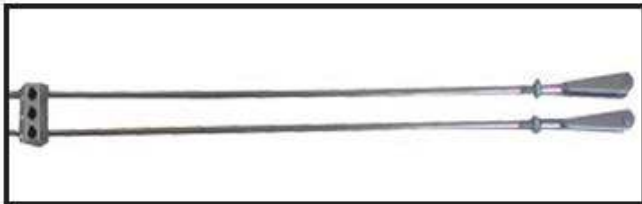

5.

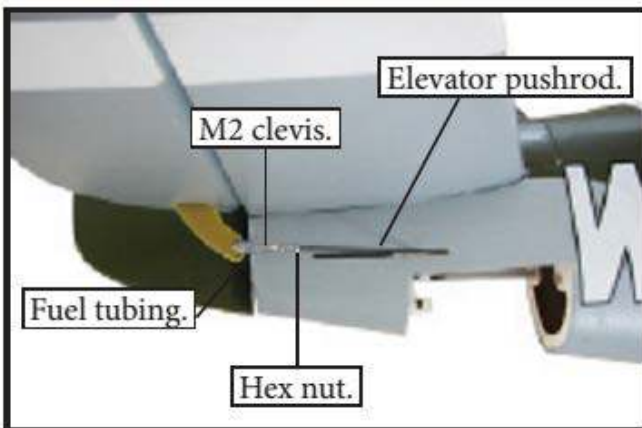

6.

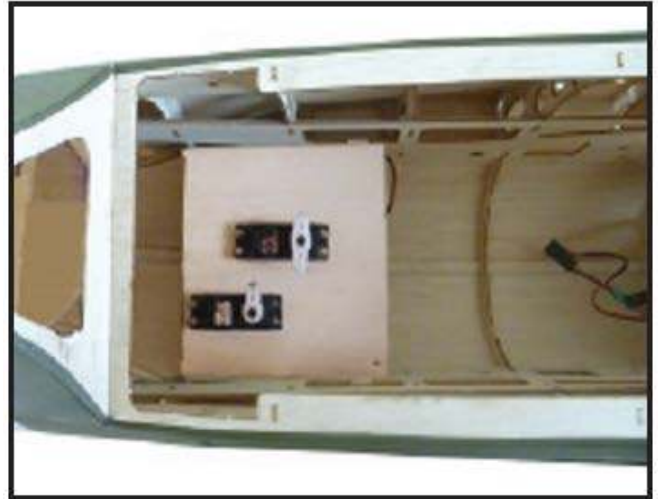

RUDDER PUSHROD INSTALLATION

- Locate items necessary to install rudder pushrod.

1.

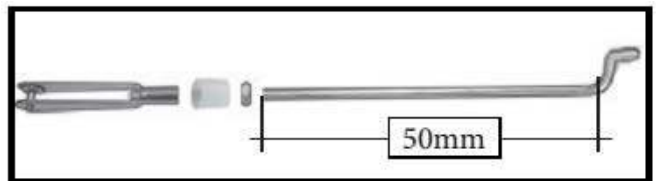

2.

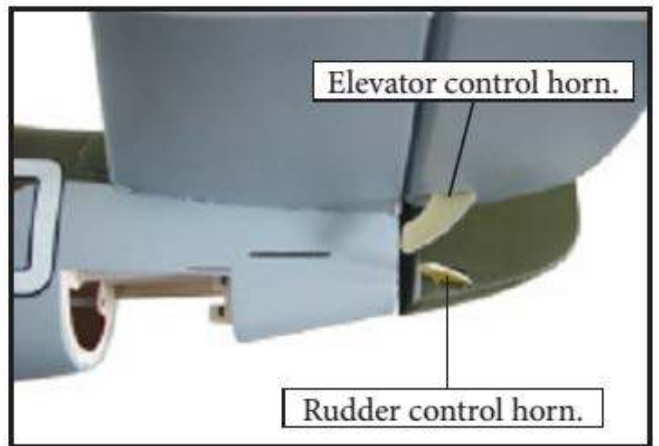

3.

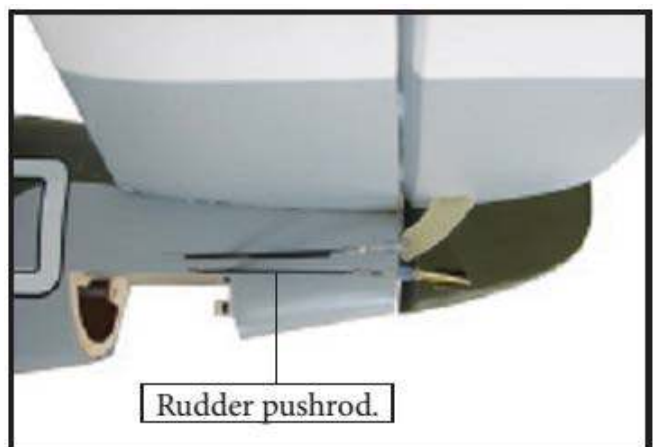

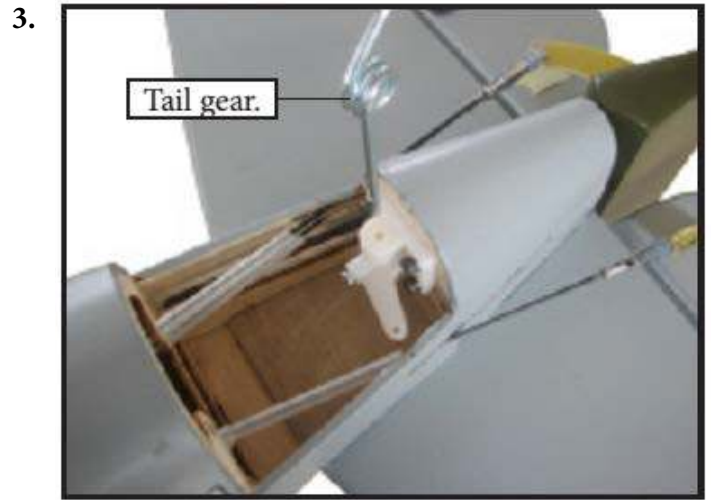
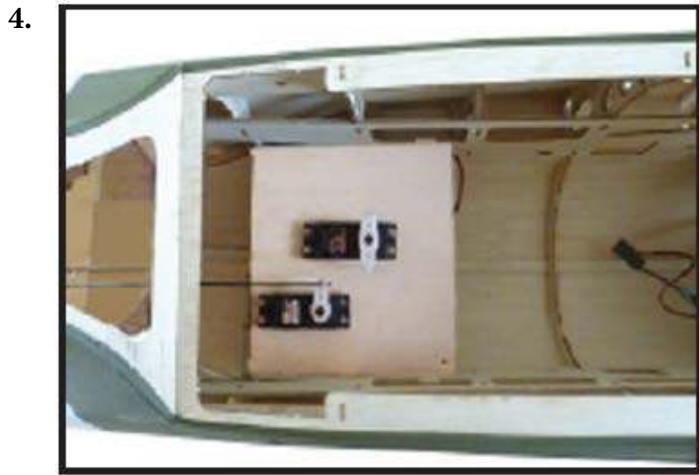

MOUNTING THE TAIL WHEEL

- Locate items necessary to intall tail wheel.

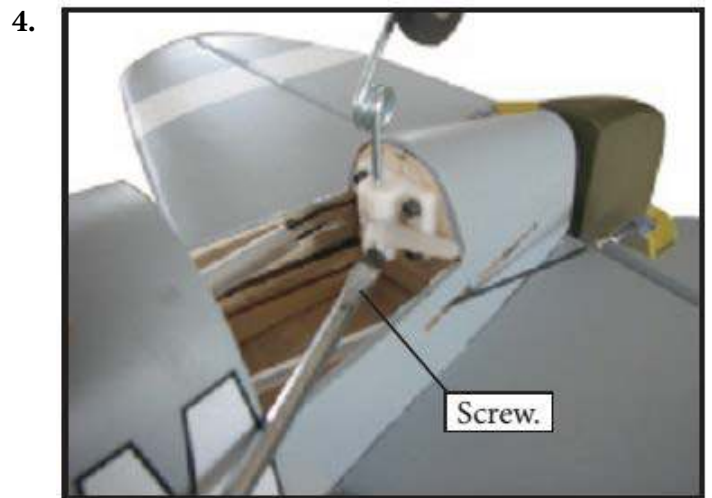

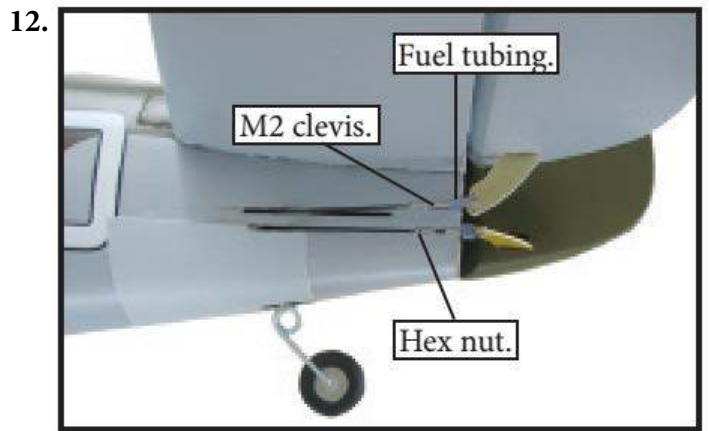
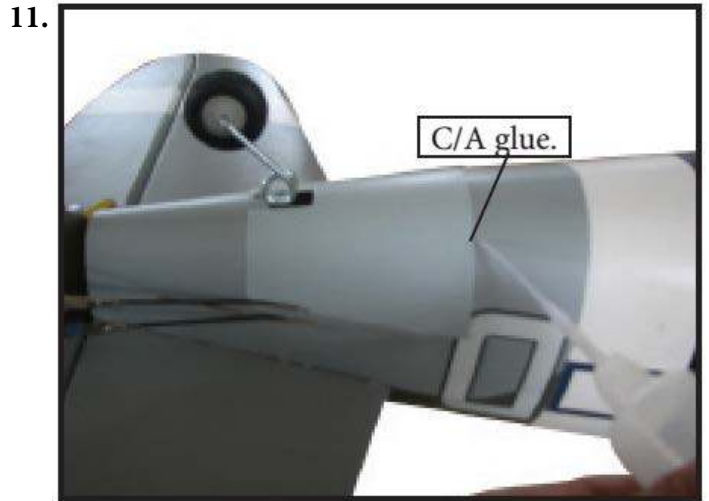
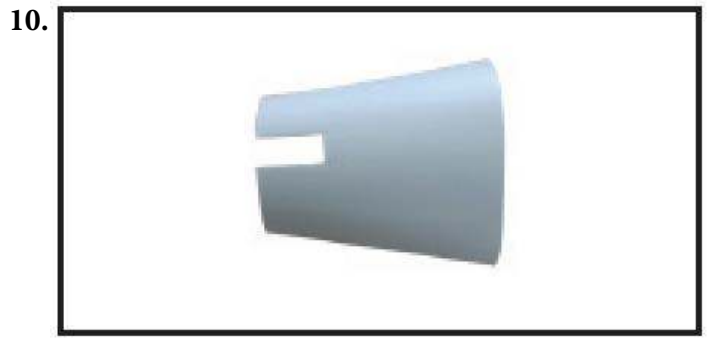
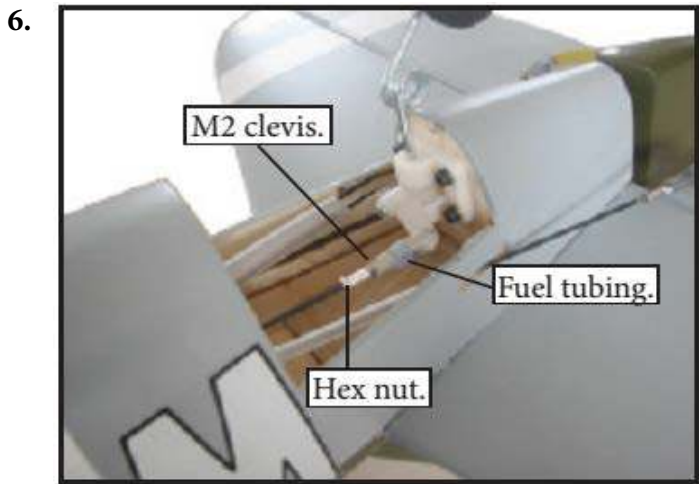

- Insert fuel tank onto the wings.

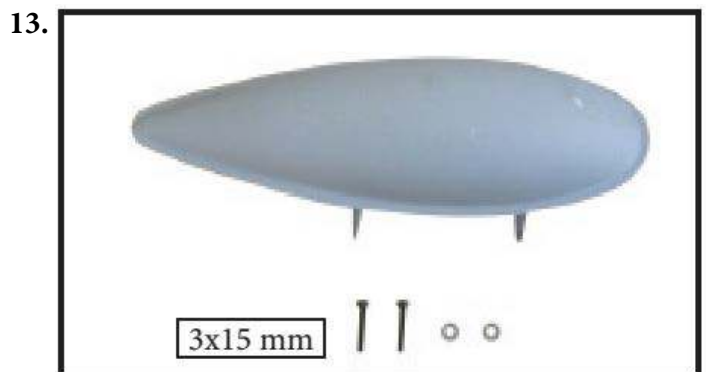

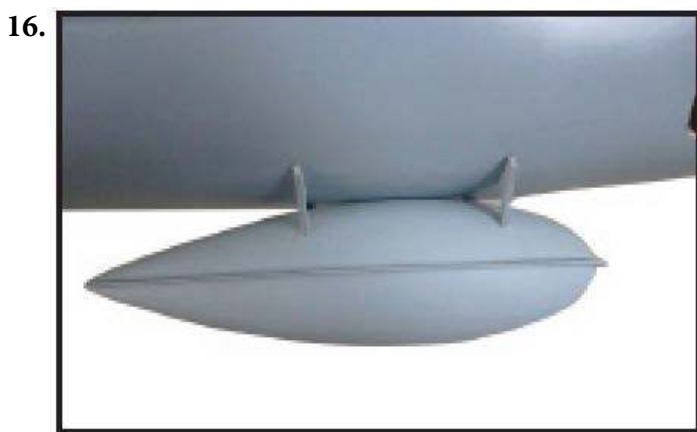
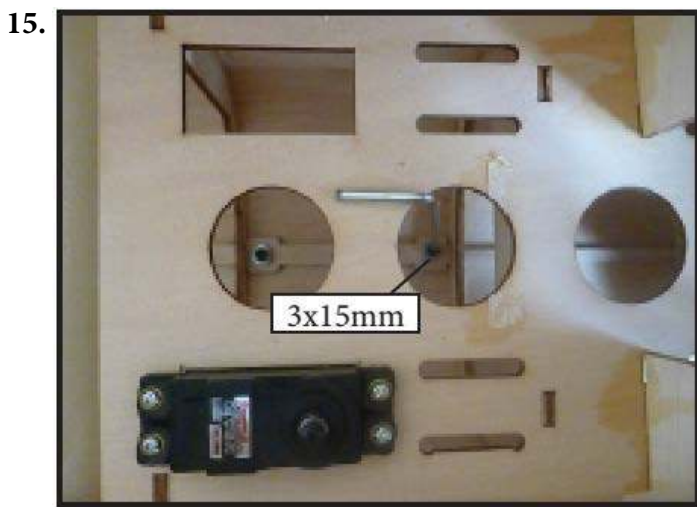
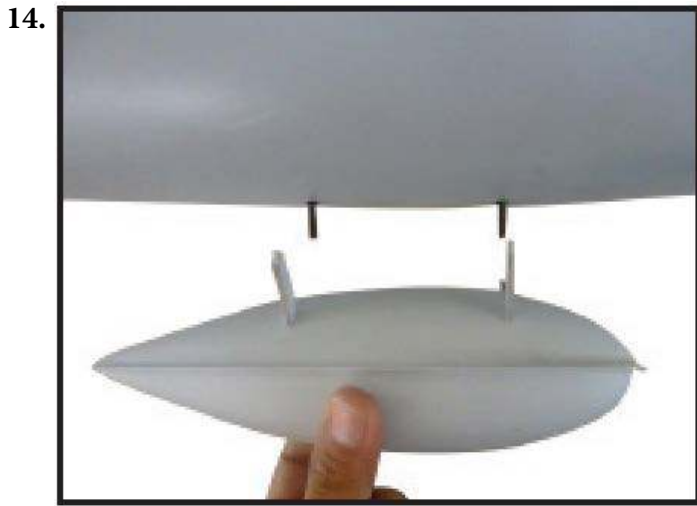

BUILD THE SERVO MOUNT

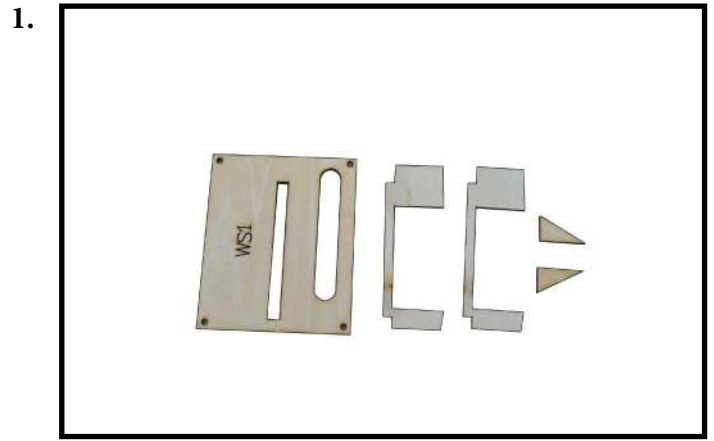

- Getting prepare set of servo mount include WS1, WS2 (2 pcs), WS6 (2 pcs) as photo.

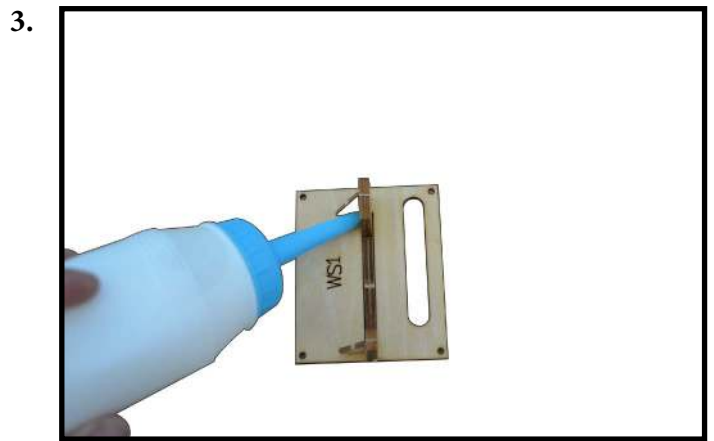
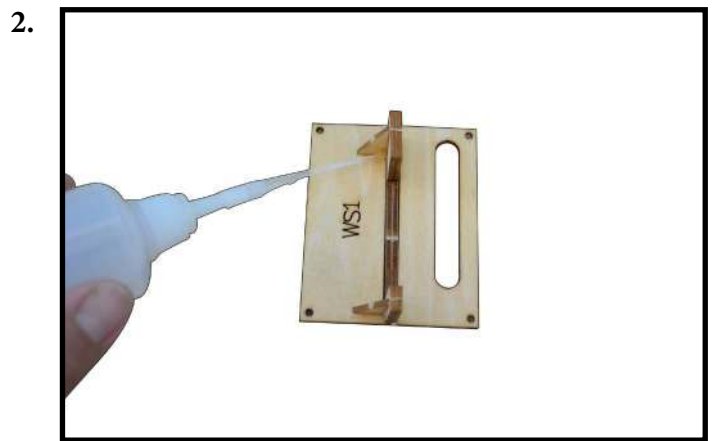

- The first, build servo mount by CA glue and then apply white glue to keep fixed.

BUILD THE MOTOR MOUNT

1.

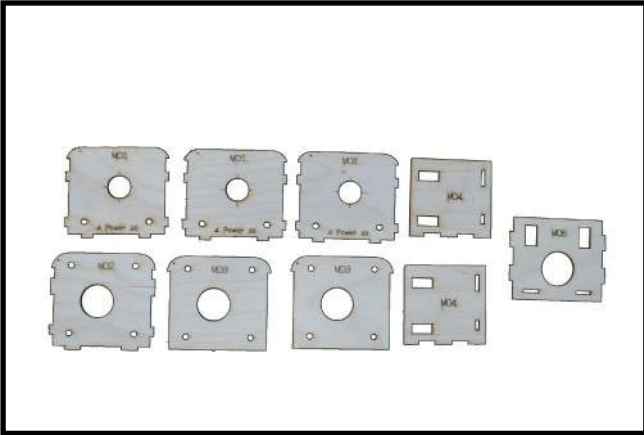

- Getting prepare set of motor mount include MO1 (3pcs), MO2 (1pcs), MO3 (2pcs), MO4 (2pcs), MO5 (1pcs).

2.



3.



4.

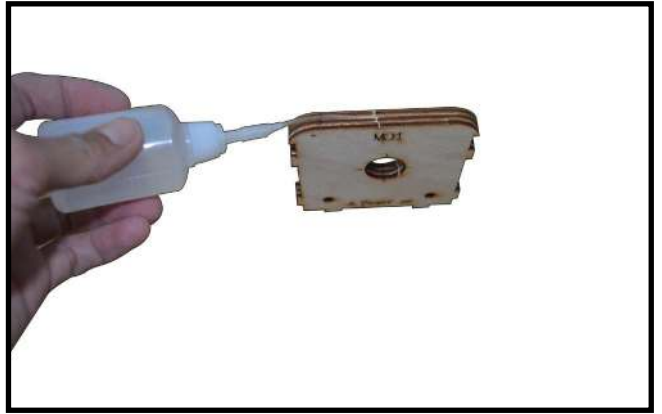

- Paste 3 pieces MO1 together by white glue and then apply CA glue around block include 3 layer to keep fixed.

5.

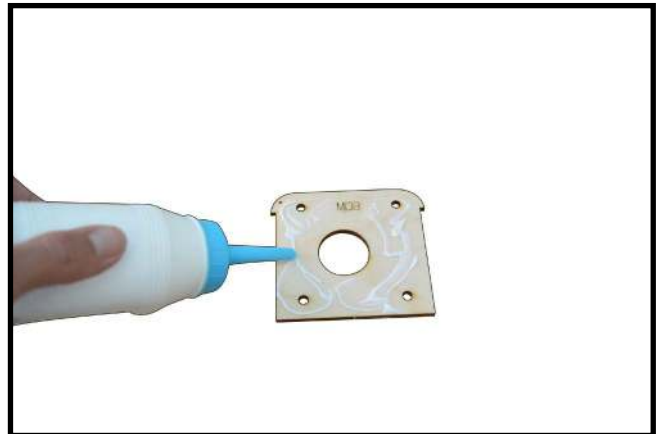

6.

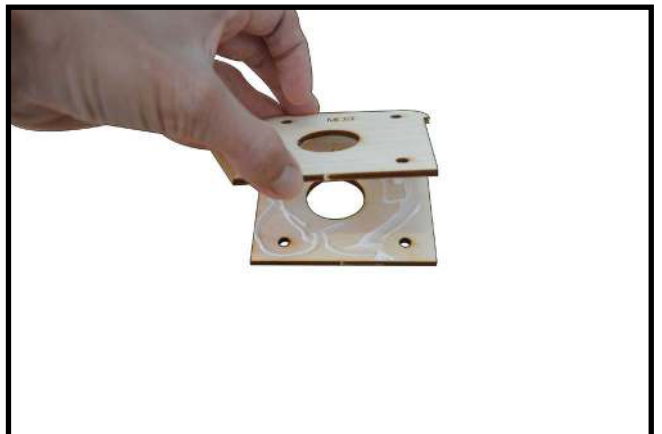

- Paste 2 pieces MO3 together by white glue.

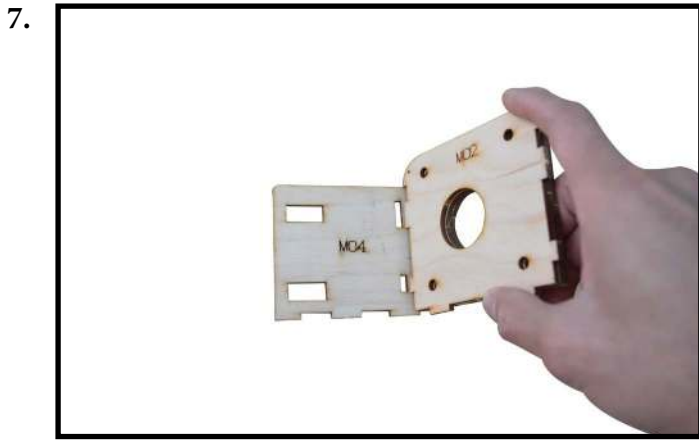

- Paste MO3 block on MO2 by white glue and apply CA glue around block include 3 layer to keep fixed. And then attach to MO4 by CA glue.

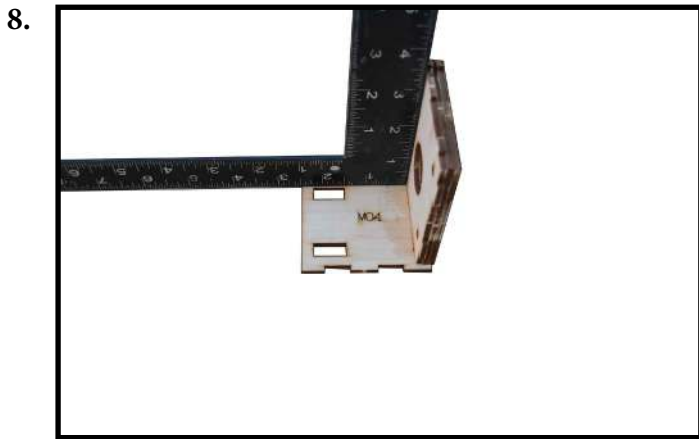

- Use perpendicular ruler for making angle 90 degree.

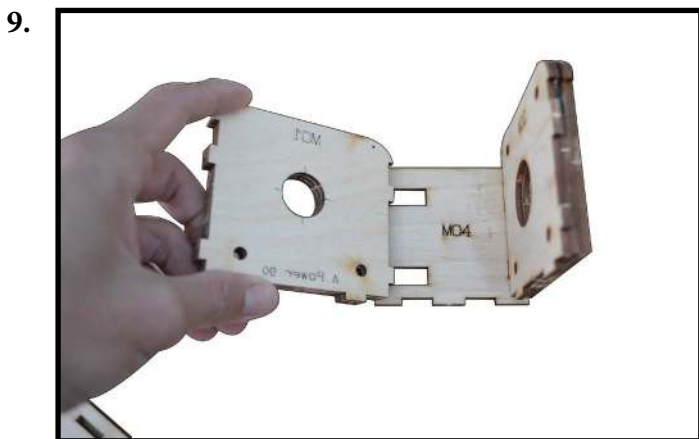

- Attach MO1 block to MO4 by CA glue(photo 9,10).

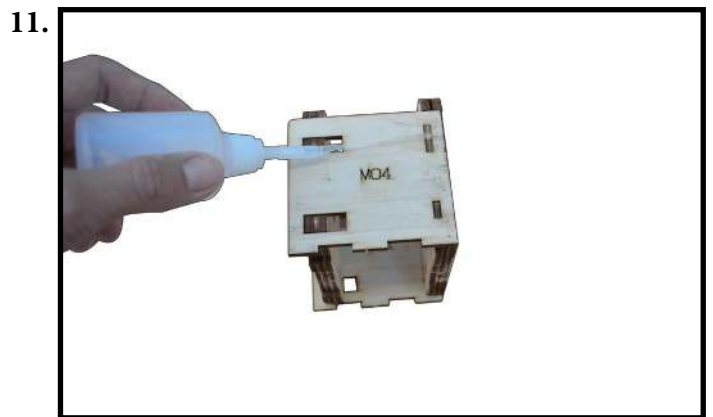

- Continue to attach the 2nd M04 by CA glue.

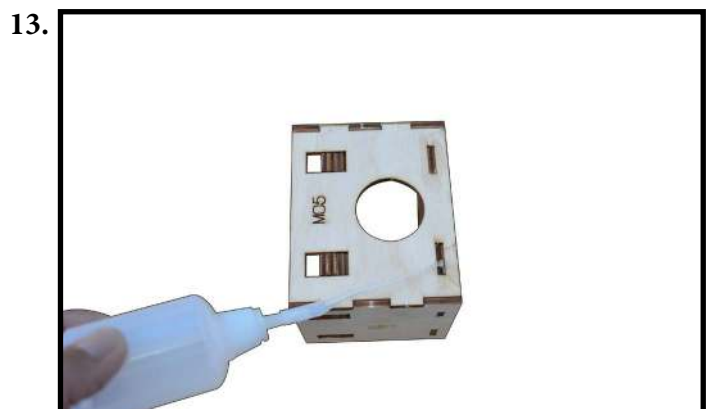
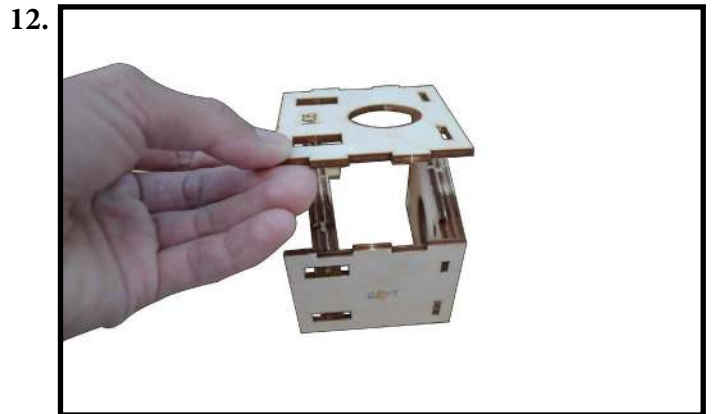

- Continue to attach M05 at the bottom of motor mount by CA glue (photo 12,13).



- Getting prepped two triangle block length = 65mm.

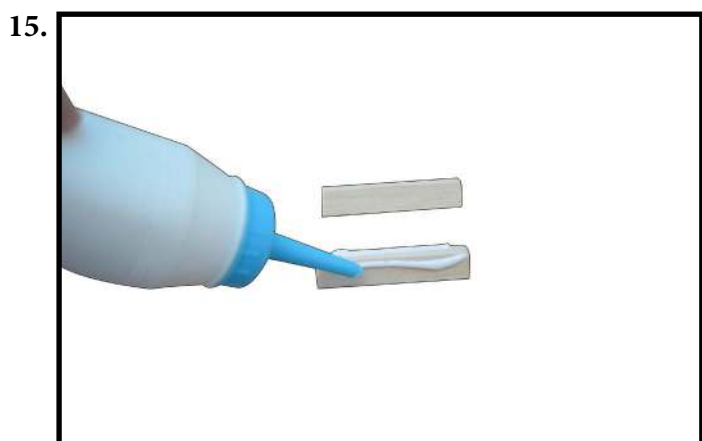

- Attach white glue to triangle block.



- Building motor mount was finished.

ELECTRIC POWER CONVERSION

- Locate the items necessary to install the electric power conversion included with your model.



- Recommend the items necessary to install the electric power conversion parts included with your model.

- **Model size: .75-.90 size models**

- **Motor: 50mm 310 rev per volt**

- **Propeller: 15x10 ~ 16x10**

- **ESC: 80A**

- **Lipo Batteries: 8 cell 5200mA**

- Attach the electric motor box to the firewall centered with the cross lines drawn on the electric motor box and firewall. Using M4x20mm to secure the motor box to the firewall. Please see pictures below.



3.

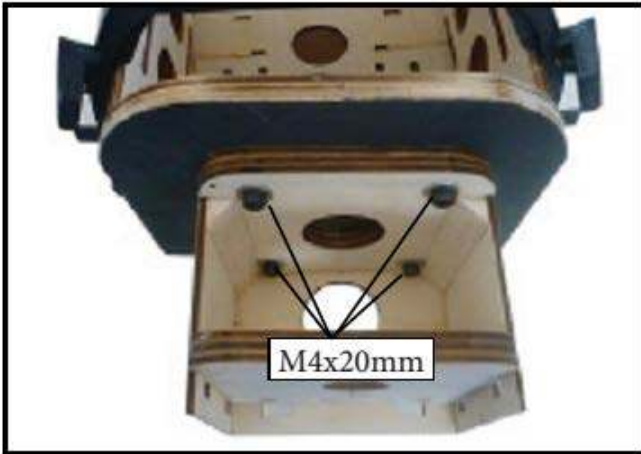

- Attach the motor mount to the front of the electric motor box using four 4mm blind nut, four M3x15mm hex head bolts to secure the motor. Please see picture shown.

6.

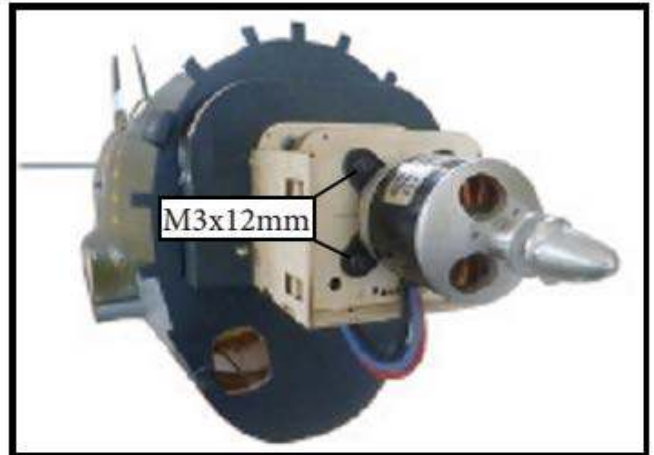

4.

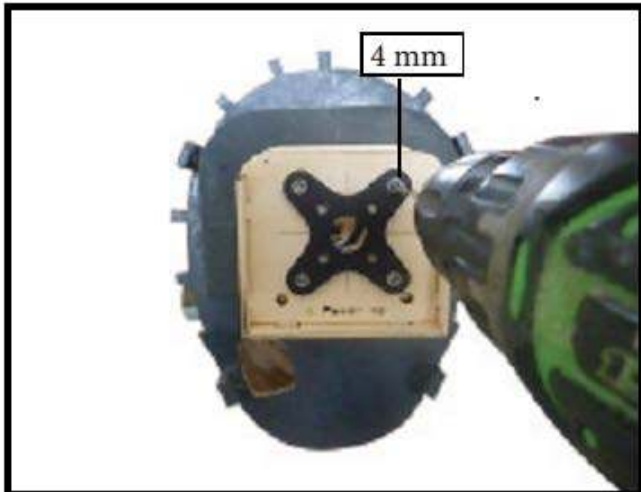

7.

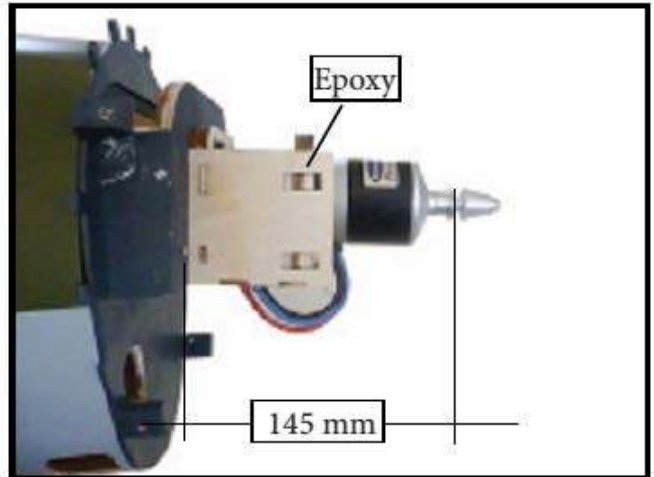

- Attach the speed control to the side of the motor box using two-sided tape and tie wraps. Connect the appropriate leads from the speed control to the motor. Make sure the leads will not interfere with the operation of the motor.

5.

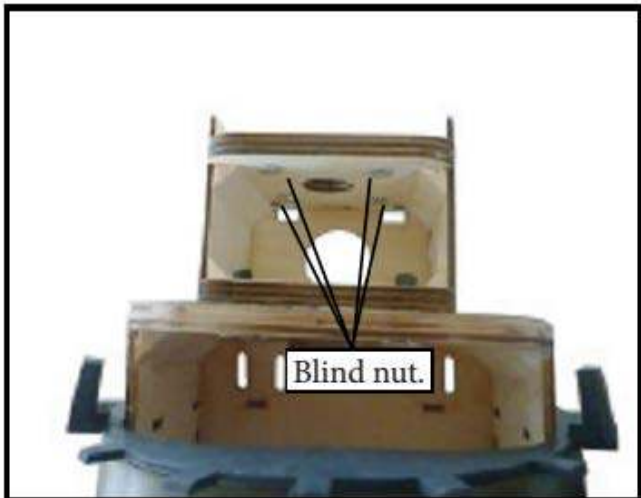

8.

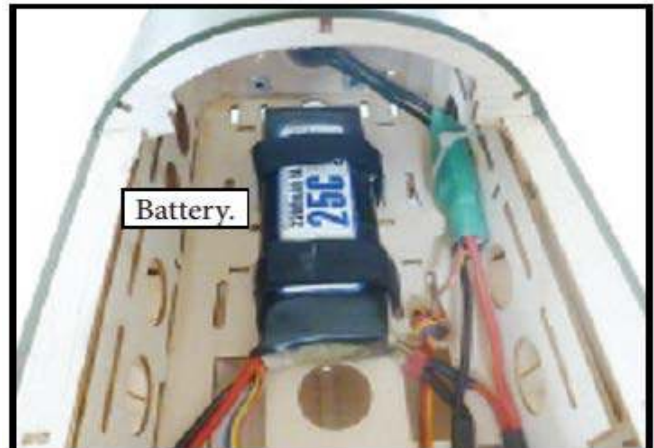

BALANCING

- It is critical that your airplane be balanced correctly. Improper balance will cause your plane to lose control and crash. THE CENTER OF GRAVITY IS LOCATED **100 MM** BACK FROM THE LEADING EDGE OF THE WING AT THE WING ROOT.

- Mount the wing to the fuselage. Using a couple of pieces of masking tape, place them on the bottom side of the wing **100=mm** back from the leading edge of the wing at the wing root.

- With the model upright, place your fingers on the masking tape and carefully lift the plane.

- Do not turn plane upside down. Only low wing models should be turned upside down for balancing. Remove this paragraph, it is not intended for use in the instructions. it is a note for you. High Wing models must be balanced upright.

- Accurately mark the balance point on the bottom of the wing on both sides of the fuselage. The balance point is located 100 mm back from the leading edge of the wing at the wing root. This is the balance point at which your model should balance for your first flights. Later, you may wish to experiment by shifting the balance up to **10mm** forward or back to change the flight characteristics. Moving the balance forward may improve the smoothness and arrow-like tracking, but it may then require more speed for take off and make it more difficult to slow down for landing. Moving the balance aft makes the model more agile with a lighter and snappier "feel". In any case, please start at the location we recommend.

- With the wing attached to the fuselage, all parts of the model installed (ready to fly), and empty fuel tanks, hold the model at the marked balance point with the stabilizer level..

- Lift the model. If the tail drops when you lift the model is "tail heavy" and you must add weight* to the nose. If the nose drops, it is "nose heavy" and you must add weight* to the tail to balance.

*If possible, first attempt to balance the model by changing the position of the receiver battery and receiver. If you are unable to obtain good balance by doing so, then it will be necessary to add weight to the nose or tail to achieve the proper balance point.

1.

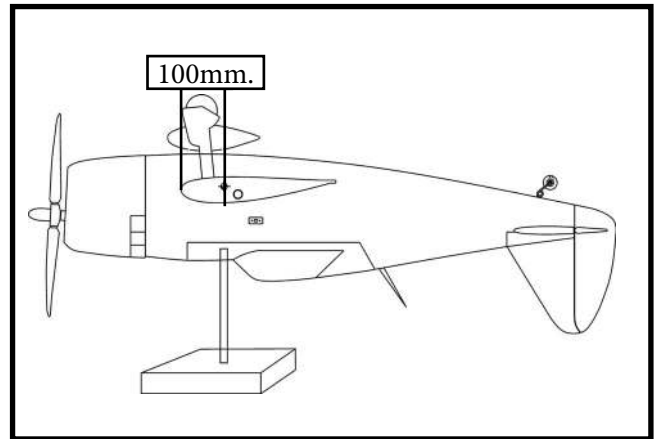

CONTROL THROWS

Ailerons:

High Rate :

Up : 15 mm

Down : 15 mm

Low Rate :

Up : 10 mm

Down : 100 mm

Rudder:

High Rate :

Right : 25 mm

Left : 25 mm

Low Rate :

Right : 20 mm

Left : 20 mm

Elevator:

High Rate :

Up : 15 mm

Down : 15 mm

Low Rate :

Up : 10 mm

Down : 10 mm

Flap:

High Rate :

Right : 25 mm

Left : 25 mm

Low Rate :

Right : 20 mm

Left : 20 mm

* Hopefully you fun for installing parts.

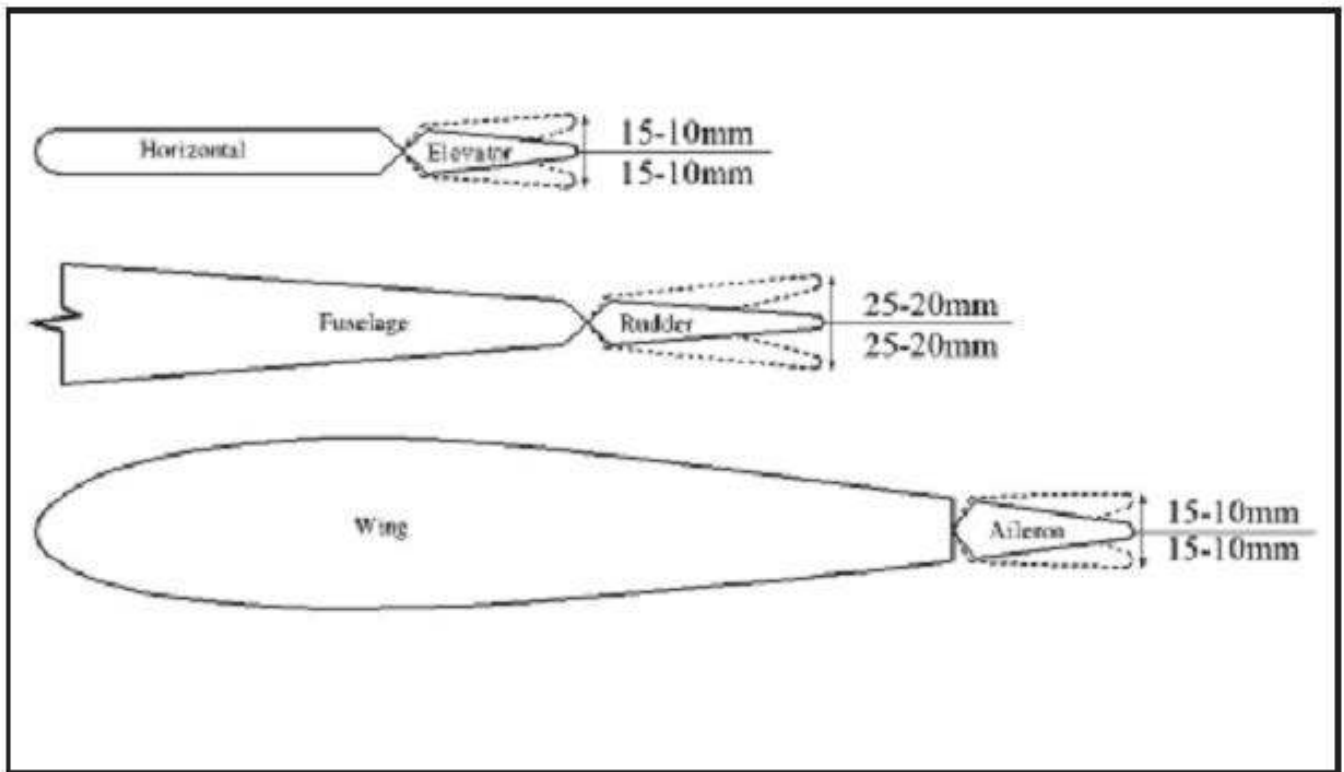

*If you have any queries, or are interested in our products,
please feel free to contact us*

Factory : 12/101A - Hamlet 4 - Le Van Khuong Street - Dong Thanh Ward -
Hoc Mon District - Ho Chi Minh City - Viet Nam.

Office : 62/8 Ngo Tat To Street - Ward 19 - Binh Thanh District - Ho Chi Minh
City - Viet Nam

Phone : 848 - 86622289 or 848- 36018777

Website : www.SeagullModels.com

Email : Sales@seagullmodels.com

Facebook : www.facebook.com/SeaGullModels.